



Operator's Manual

(Original)

en (English)



FOREWORD

This manual explains the proper operation and maintenance of your forklift truck as well as daily lubrication and periodic inspection procedures.

Please read this manual thoroughly even though you may already be familiar with our forklifts, because it contains information which is exclusive to this series of trucks. This manual is based on a standard truck. If you have any questions about other types, please contact the Manufacturer's Service Centre.

In addition to this manual, please be sure to read the separate publication entitled "Manual for Safe Operation".

The factory reserves the right to make any changes or modifications of specifications in this manual without giving previous notice and without incurring any obligation.

Illustrations may differ from actual design.

(OPT) in this manual designates optional equipment.

CONTENTS

Foreword	2 (En-1)
Contents	2 (En-1)
Before Initial Operation	2 (En-1)
Safety	3 (En-2)
Frame Serial Number	4 (En-3)
Identity and Capacity Plates	4 (En-3)
Caution Plates	5 (En-4)
Main Components	6 (En-5)
Driving Controls and Instruments Panel	6 (En-5)
Dashboard	7 (En-6)
Switches and Levers	18 (En-17)
Body Components	21 (En-20)
Pre-operation Check	25 (En-24)
Self Servicing	27 (En-26)
Periodic Maintenance	30 (En-29)
Service Data	34 (En-33)
Truck Dimensions	36 (En-35)
Example of CE declaration of conformity	37 (En-36)

BEFORE INITIAL OPERATION

- **Please read this manual thoroughly.** This will give you a complete understanding of your forklift and enable you to operate it correctly and safely. Proper handling of new trucks promotes performance and extends life. Drive with special caution while becoming familiar with a new truck. In addition to the standard operating procedures, pay attention to the following safety items.
- **Please acquire a thorough knowledge of the your forklift truck.** Read the operator's manual thoroughly prior to operating the truck. Get to know its operation and components. Learn about the safety devices and accessory equipment and their limits and precautions. Be sure to read the caution plate attached to the truck.
- **Please familiarize yourself with safe driving techniques and safety management.** Understand and maintain work area traffic rules. Ask the work area supervisor about any special working precautions.
- **Wear neat clothing for operation.** Improper clothing for truck operation may interfere with smooth operation and cause an accident. Always wear proper clothing for easy operation.
- **Avoid electric power lines.** Know the locations of inside and outside power lines and maintain sufficient distance.
- **Be sure to perform pre-operation checks and periodic maintenance.** This will prevent sudden malfunctions, improve work efficiency, reduce costs, and help ensure safe working conditions.
- **Be sure to avoid forward tilt when the loaded forks are raised.** In the worst case, this will cause overturning due to poor stability resulting from forward shifting of the center of gravity.
- **If you hear any abnormal noises or sense anything unusual, inspect and repair immediately.**
- **Never attempt traveling with a load on the forks lifted beyond the specified height.** Traveling with a load on the forks lifted beyond the specified height may cause overturning due to upward shifting of the center of gravity. Refer to Manual for Safe Operation.
- **Avoid overloading or uneven loading.** Overloading or uneven loading is dangerous. If the center of gravity is closest to the front side even though the load is below the maximum, limit the loading weight according to the name plate.
- **Avoid reckless operation.**
- **Use only the recommended lubricants.** Low-grade lubricants will shorten service life.
- **Do not overdischarge.** Always check the condition of the battery.
- **Avoid open flames during charging.** Combustible gas is produced during charging. Charge away from open flames in a well-ventilated place.
- **Do not make any alterations to the electrical system.** Any attempt to do so may affect the operation of the precision devices built into the battery-operated forklift, causing a malfunction or accident. If any alterations become necessary, contact the Manufacturer's Service Centre.
- **When washing the forklift, be careful not to splash the motor or electrical parts directly with water.** If the motor or electrical parts are directly splashed with water, the forklift may malfunction or break down. If it becomes unavoidable to wash the battery-operated forklift, carefully cover electrical parts with a insulating material panel to protect them from getting wet.
- For trucks that are equipped with non-marked or color tyres, be sure to install a static strap.
- **Cold Storage Models (OPT).** The limit of continuous operation for cold storage models in a refrigerated warehouse is 30 minutes, with 30 minutes at ambient temperature before returning to cold store. The limit of operating temperature is -28 °C. Be sure not to exceed this limit, or it may result in breakdown of the truck.

Cautions for thunder

- If thunder can be heard in the distance, stop charging the battery and disconnect the charging plug.
- If thunder can be heard close by, do not touch the power supply plug or cord because you may receive an electric shock if lightning strikes close by.
- Setup of a lightning rod or a lightning arrester in the electric circuit is strongly recommended in areas where thunder is frequently heard.



SAFETY

Safety requirements

Truck equipped with a load bearing clamp (e.g. paper clamp) shall feature control(s) with a secondary action to prevent unintentional release of the load.

When any "load bearing clamp" is used on a lift truck, the control (hydraulic hand lever for example) must be configured to conform to the ISO3691.

Using the model with SAS (System of Active Stability)

⚠ Warning

Whenever you drive a SAS model, please check the caution plate to discover which functional features the truck has. Do not operate the truck before making sure that each of the features is operating properly.



- While driving the truck, be alert for warning indicators and/or alarm buzzers.
- The SAS, which is electronically controlled, must be initialized after maintenance is performed. Do not remove or modify any SAS features. Whenever an inspection is necessary, contact your dealer.
- When washing the truck, carefully prevent water from splashing directly over the electronic components (controller, sensors and switches) employed in the SAS.

Description of features available in SAS models

Active control rear stabilizer

When the truck makes a turn on the spot, a centrifugal force is generated in the lateral direction of the truck. In such an event, this feature will operate so that the rear wheels will be locked to prevent swinging and the truck will be supported on four wheels. Thus, vehicular stability will be enhanced in both right and left directions.

⚠ Danger

With the truck locked to prevent swinging, stability increases. Nevertheless, it is not the case that the truck will never tip over. Always operate the truck correctly.

Automatic forks leveling control

- With the truck not loaded, press the tilt lever knob button to turn it on and tilt the mast forward. This will cause the forks to stop automatically in a horizontal position (with the mast in the vertical position).
- After pressing the tilt lever knob button and stopping the forks in a horizontal position, you may want to tilt the mast further. To do this, return the tilt lever to the neutral position once. Then, press the tilt lever knob button to turn it off and operate the tilt lever.

When the tilt lever knob button is turned on and the tilt lever is operated from the backward to forward position, the mast will perform as follows:

	Not loaded	Loaded
High lift height	Stop with leveling forks (mast vertical)	No front tilt
Low lift height	Stop with leveling forks (mast vertical)	Stop with mast vertical (or up to 1° to rear side) depending on the load

⚠ Danger

- If you press the tilt lever knob button while the mast tilted forward with a heavy load at high lift, the mast will stop operating. Do not operate the automatic forks leveling control during material handling operation because the truck may tip over.
- In case of a truck with an attachment, do not allow the forks to be automatically positioned horizontally with a heavy load at a high lift while the motor is running at a high speed. This will lead to a hazardous situation.
- Mounting heavy attachments onto some specialty models may disable automatic forks leveling control. Confirm with your dealer in advance.

Notice:

- The mast will not tilt forward if the tilt lever knob button is turned on while there is a heavy load at high lift (2 m or more).
- When the mast is tilting forward from a vertical position, it will not tilt further forward even if the tilt lever knob button is turned on.
- When the mast is tilting backward, the forks will not stop in a horizontal position even if the tilt lever knob button is turned on.

Active mast forward tilt angle control

According to lifting height and load, the angle at which the mast can be tilted forward is automatically controlled within a range of angles illustrated below.

	Light load (no load)	Intermediate load	Heavy load
High lift height	No restriction for front tilt angle	Front tilt angle is restricted from 1° to 5°	Front tilt angle is restricted to 1°
Low lift height	No restriction for front tilt angle		

⚠ Danger

- If a load is lifted while the forks are tilted forward at a low lift, the truck may tip over when the forks stop at a position having a tilt angle beyond the specified angle range. Never lift the load, therefore, while the mast is tilted.
- With a heavy load at a high lift, never adjust the load position by controlling the mast forward tilt angle, as the truck may tip over.
- Even with a load positioned within the allowable angle range, never tilt the mast beyond its vertical position, or the truck may tip over, losing its stability forward and backward. Never tilt the mast forward when a load is lifted.
- Mounting heavy attachments onto some specialty models may disable active mast forward tilt control. Confirm with your dealer in advance.
- After mounting or replacing any attachment have it inspected at your dealer.
- If you use two or more removable attachments alternately, the heaviest one should be used to carry out matching (SAS setting). Ask your dealer for help in advance.

Notice:

With the forks raised to the maximum height, high pressure (relief pressure) may remain in the lift cylinder. This high pressure causes the truck to judge that it has a heavy load even if unloaded. As a result, forward tilting of the mast is disabled. In this case, lower the forks slightly from the top (to release the pressure), and the mast can be tilted forward.

Active mast backward tilt angle control

When the tilt lever is operated backward from the forward tilt position with the automatic fork leveling control switch depressed, the fork automatically levels itself (mast vertical) and then the mast tilting stops.

Note that only the load conditions changes its operation as shown below:

	Not loaded	Loaded
High lift height	Stop with leveling forks (mast vertical)	Stop with mast vertical (or up to 1° to rear side) depending on the load
Low lift height		

The value of load weight judged as "loaded" is same as the intermediate load on Active mast front tilt angle control.

Active mast forward/backward tilt speed control

Notice:

- At a high lift, the mast forward or backward tilt speed is controlled (slowed down) regardless of load weight. Even if the lifting height changes from high to low while the mast tilts forward or backward, the control speed will remain in effect.
- At a low lift, the mast can be tilted backward at full speed regardless of load weight. If the tilt lever knob button is turned on and the mast tilted backward at a low lift, the backward tilt speed of the mast is controlled (slowed down) as long as the tilt lever knob button is turned on.
- If the forks are raised from a low lift to a high lift while the mast is tilting backward, the control speed will remain in effect as long as the tilt lever knob button is turned on. The mast tilts backward at the maximum speed when the tilt lever knob button is turned .
- The forward/backward tilt speed control is controlled by the rpms of the pump motor. Never lift at a high lift or perform simultaneous operation of attachment and tilt.

Key-lift interlock

With the key switch at OFF, the forks will not lower even if the lift lever is so operated.

Active steering synchronizer

If the steering wheel knob is not aligned with the tyres, the offset will be corrected automatically while the steering wheel is turned. Thus, the knob is kept at a constant position relative to the tyres.



If the SAS feature should fail:

An SAS model is controlled with a controller, sensors and various actuators. If any of them is found not to be operating normally, the following may occur:

- Steering wheel knob offset may not be corrected.
 - Such features as automatic forks leveling control, active mast forward tilt angle control and active mast forward/backward tilt speed control may be disabled.
 - Swing lock may not be unlocked.
- If any of the phenomena referred to above should take place,
- Diagnosis operation indicator will come on.
 - An error code will be displayed.
 - A buzzer will sound.

Thus, the operator will be informed. In such an event, move the truck to a safe location and have it repaired at your dealer.

OPS SYSTEM

The OPS (Operator Presence Sensing) system prevents traveling and load handling operations when the operator is not seated in the operator's seat. If the operator leaves the seat while the truck is in operation, the OPS indicator will be displayed on the screen and a buzzer will sound for 0.5 seconds to inform the operator that the system is going to be activated. If the operator remains away from the seat for 2 seconds, the system will be activated and stop the current operation. However, if the operator returns to the seat within 2 seconds, the system will not be activated and operation can be continued normally.

If an error occurs within the OPS system, an error code will be displayed on the screen to inform the operator of the error. This indicates that the OPS system may be faulty. Have the truck inspected by your dealer.

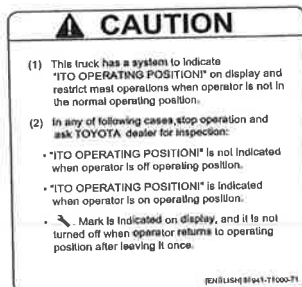

This truck is equipped with the OPS system. Confirm the functions of the OPS system before operation.

Travel OPS Functions

When the controller detects the seat switch turned off for two seconds, the drive motors stop after acting as the regenerative brake.

Travel OPS is released by returning the direction lever and accelerator pedal to the neutral position and turning on the seat switch. On the D2 pedal truck or the Double Accel pedal truck, releasing the accelerator pedal makes the direction signal neutral, then it cancels the travel OPS.

Here, the degree of the regenerative brake changes depending on the detected height and weight of the load as follows:

	Light load (no load)	Loaded
High lift height	Regenerative brake same as that of the accelerator pedal off	The regenerative brake decreases as the weight of load increases
Low lift height	Regenerative brake same as that of the accelerator pedal off	

Load Handling OPS Functions

Mini-lever or joystick truck

When the controller detects that the seat switch is turned off for 2 seconds, controlling the electric proportional valves stops the movements of lift, tilt, and attachments. At the same time, the lift lock valve and tilt control valve stop lifting down and tilting forward. The movement of lift up and attachment are also stopped because the supply of the hydraulic oil is intercepted by controlling the unload valve.

Hydraulic function OPS is released by returning all the levers to the neutral positions and turning on the seat switch.

OPS Operation Alarm Functions

When the controller detects that the seat switch is turned off, the onboard buzzer in the multi-function display informs OPS operation to the operator by sound (pipi-) for 1 second. And the multi-function display turns on the OPS indicator in advance at that time.

If the operator notices it and sits down before 2 seconds pass, the OPS will not activate.

In order to inform that the OPS is operating, the OPS indicator keeps being turned on while the seat switch is turned off.

Load Handling Functions

When the seat switch is turned on without returning the hydraulic control lever to the neutral position, sounding (pipipipi) informs the operator that the hydraulic function OPS is not released.

Return to neutral warning

When traveling motion is stopped by the OPS system, sitting in the seat and depressing the accelerator pedal without returning the direction lever to its neutral position will sound a buzzer to indicate that the motion stop has not been released. Sitting in the seat with the accelerator pedal depressed will also activate this alarm.

OPS Controller Abnormality Warning

If an error occurs within the OPS system, an error code is displayed on the screen to inform the operator of the error. This indicates that the OPS system may be faulty. Park the truck in a safe location and have it inspected by your dealer. Also, in any of the following cases, stop operation and have the truck inspected by your dealer.

- The OPS indicator is not displayed on the screen when the operator leaves the seat.
- The OPS indicator does not turn off when the operator sits in the seat.

Emergency switch off

In the event of an emergency (i.e. in case of accident or to prevent one) fully press the brake pedal, and press the emergency stop button to disconnect power and stop all truck movement (drive and lifting).

Auto-off function

The truck turns off after a set time period (10 minutes as standard), if the operator leaves the truck (with parking brake activated).

RECYCLING/DISCARDING

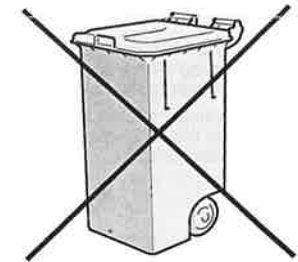

The forklift truck uses a lead accumulator and, in case of some battery powered truck, a lithium battery.

Materials contained in batteries (include accumulators) are hazardous to the environment and humans, so batteries should be returned to the manufacturers for recycling.

Discarding the battery

When the working life of the battery in the truck is at an end (exchange to a new battery) or if the entire truck is to be scrapped, special regard to the environment risks shall be taken when disposing/recycling batteries.

Consult the manufacturer about exchange or discarding the batteries.



FRAME SERIAL NUMBER

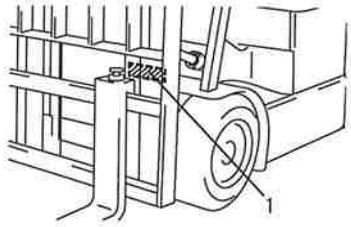

(1) Frame serial number location

Frame serial number location

The frame serial number is stamped on the front cross plate. Please refer to the frame serial number when making inquiries about your truck.

IDENTITY AND CAPACITY PLATES

Check the load center and capacity before starting operation.

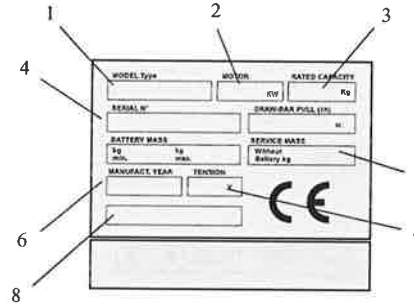

Identity plate

1. Truck model
2. Motor power
3. Nominal rated capacity
4. Truck serial number
5. Truck weight (without battery)
6. Year of manufacture
7. Battery voltage
8. Notes

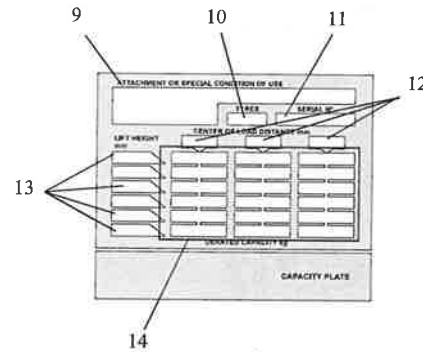

Capacity plate

9. Specialty model, Attachment model
10. Truck tyres
11. Truck serial number
12. Load center
13. Lift height
14. Actual capacity



CAUTION PLATES

Caution plates are attached to the truck. Before driving it, be sure to read them thoroughly.
(The sample shows the English version.)

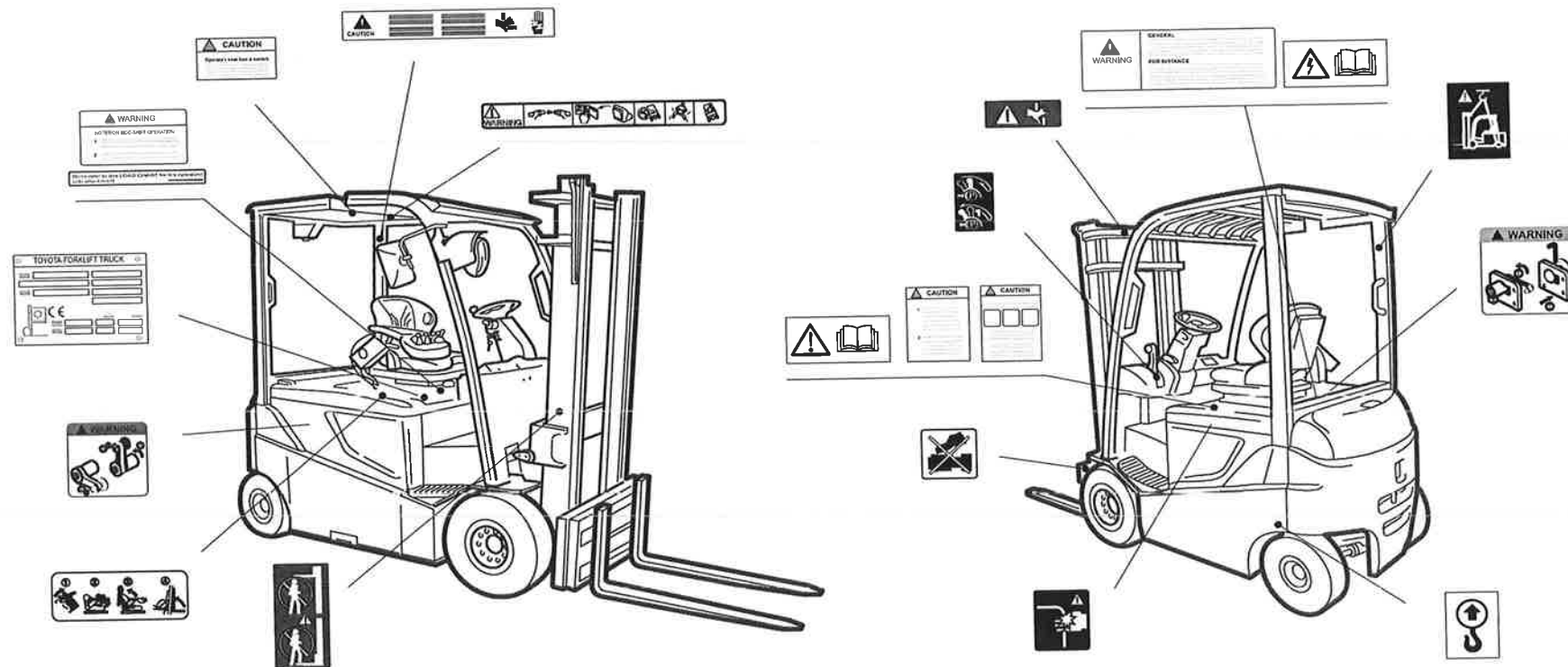

About this mark
Warning! Please read this Operator's Manual carefully before use.



MAIN COMPONENTS

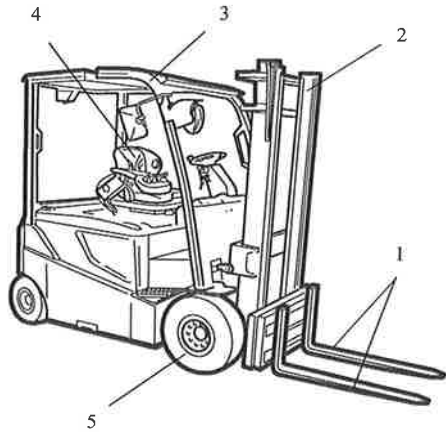

- (1) Forks
- (2) Mast
- (3) Overhead guard
- (4) Operator's seat
- (5) Front wheel

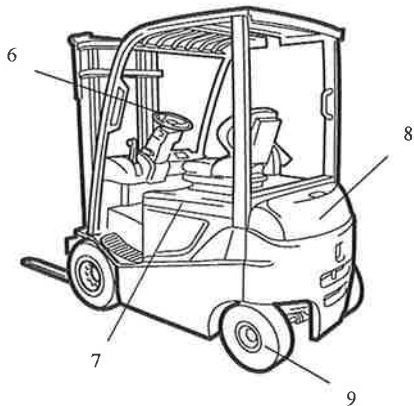

- (6) Steering wheel
- (7) Battery hood
- (8) Counterweight
- (9) Rear wheel

DRIVING CONTROLS AND INSTRUMENT PANEL

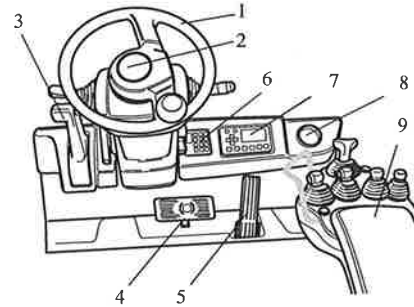

- (1) Steering wheel
- (2) Horn button
- (3) Parking brake lever
- (4) Brake pedal
- (5) Accelerator pedal
- (6) PIN code entry system (OPT)
- (7) Multi-function display
- (8) Cup holder
- (9) Armrest

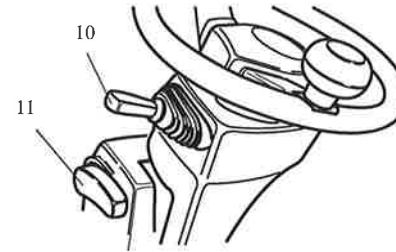

- (10) Lefthand direction lever (OPT)
- (11) Steering column tilt adjust lever

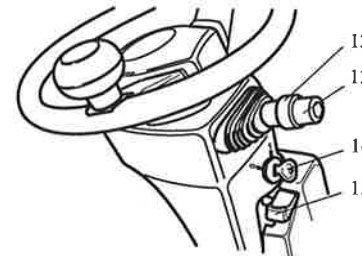

- (12) Light switch (OPT)
- (13) Turn signal switch (OPT)
- (14) Key switch
- (15) Steering column lock lever

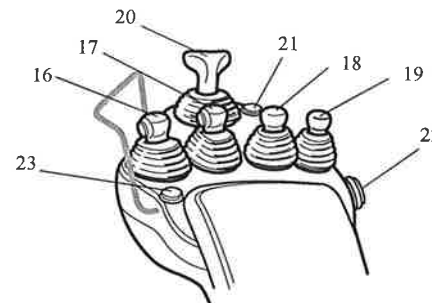

- (16) Lift lever
- (17) Tilt lever
- (18) Attachment lever
- (19) Attachment lever (OPT)
- (20) Direction lever
- (21) Height limiter (OPT)
- (22) Emergency stop button
- (23) Horn button (OPT)

En



DASHBOARD FUNCTIONS

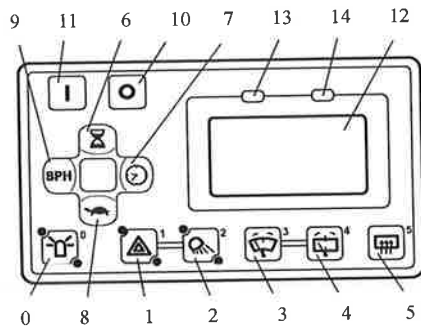

DASHBOARD

Buttons:

- (0) Rotating / Flashing beacon
- (1) Hazard lights
- (2) Rear work lights
- (3) Front wiper
- (4) Rear wiper
- (5) Heated rear window
- (6) Hour meter
- (7) Clock
- (8) Speed reduction
- (9) Power Selection
- (10) OUT button
- (11) OK button

Other:

- (12) Display
- (13) Warning light (red led)
- (14) Operation light (green led)

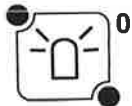

Rotating / Flashing beacon (OPT)

Press button (0) to turn the rotating or flashing beacon ON. The upper led will light up. Press it again to turn it OFF.

Hazard lights (OPT)

Press button (1) to turn the hazard lights ON. Press it again to turn them OFF.

Rear work lights (OPT)

Press button (2) to light up the rear work lights. Press it again to turn them OFF.

Front wiper (OPT)

- Press button (3) n times:
1. intermittent speed
 2. high speed
 3. OFF

Keep button (3) pressed to activate the washer.

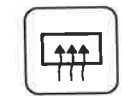
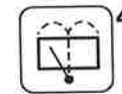

Rear wiper (OPT)

Press button (4) to turn the rear wiper ON. Press it again to turn it OFF. Keep button (4) pressed to activate the washer.

Heated rear window (OPT)

Press button (5) to turn the heated rear window ON. Press it again to turn it OFF.

Notice:

When the heated rear window is ON, an icon appears on the operating screen. The heated rear window goes automatically OFF after 15 minutes.

Hour meter

Keep button (6) pressed to access the Hour meter menu (see Operator Menu chapter).

Clock

Press button (7) to switch between hour and date. Keep button (7) pressed to access the Clock set menu (see Operator Menu chapter).

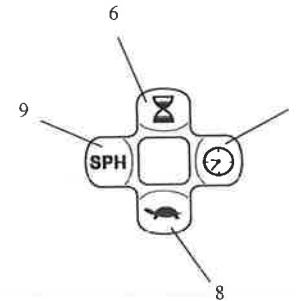

Speed reduction

This setting limits the maximum travel and lifting speed of the truck. Press button (8) to turn the speed reduction ON. Press it again to turn it OFF. Keep button (8) pressed to access the Speed menu (see Operator Menu chapter).

Power selection

Press button (9) to change the traveling/material handling power select mode; this function is disabled if the forklift is operating.

Power modes:

- S: high efficiency
- P: balanced
- H: high performance
- SPH: custom (set by user) (OPT)

Keep button (9) pressed to access the Power selection menu (see Operator Menu chapter).



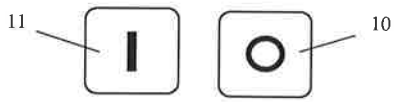

OK - OUT buttons

OK (11) and OUT (10) buttons are used to navigate the user menu.

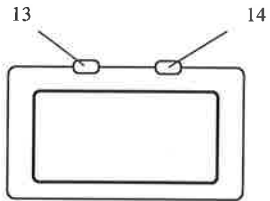

Warning light - Operation light

Red Warning light (13) blinks when an error occurs.
Green Operation light (14) is lit while the truck is ON.

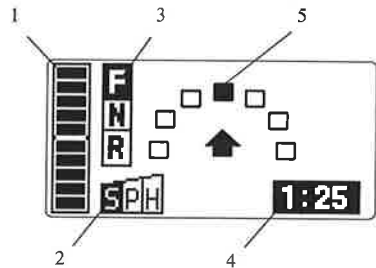

DISPLAY INDICATORS

Operating screen

The operating screen indicates several informations during truck operations:

- (1) battery charge level
- (2) power selected mode
- (3) selected travel direction
- (4) time
- (5) wheels direction

Battery charge level and wheels direction are displayed only if the forklift is stationary or running at low speed.



Battery discharge indicator

It starts flashing when the battery charge level falls to 20%. At 10% the red led also starts to flash. At 0% the buzzer will also sound.

Notice:

When the battery charge level falls to 20% truck travel and lifting speed will be lowered. When it reaches 10% of the charge they will be further lowered.



Power selected mode

It shows the traveling/material handling performance mode currently selected.



Selected travel direction

The pre-set traveling direction (by direction switch) is indicated. An upward arrow indicates forward traveling direction, while a downward arrow indicates reverse traveling direction.



Time

It shows time: hour and minute.

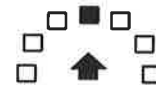

Wheels direction

Steering direction can be indicated in one of two ways, selected by the operator. The indication is only visible at low speed.

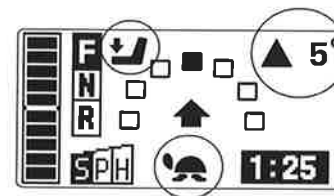

Other indicators

Other indications may be displayed. Some of them can be optional.



Speed reduction setting

This indicator comes on or goes off whenever the operator presses the speed reduction switch. This indicator is lit when the low speed is effect, limiting the truck speed at a preset value.



OPS

This indicator lights when the operator leaves the seat.



Mast tilt (OPT)

Up arrow indicates forward tilt; down arrow indicates backward tilt. The tilt angle of the mast is displayed in unit of 1 degrees.



ALARMS

Some errors are generated by incorrect operations when starting the truck or when operating controls. Those errors block temporarily the truck functioning, generating a full-screen alarm icon on the display. Most errors are recoverable.

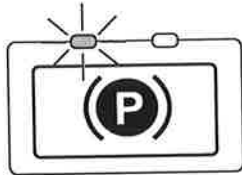

Parking brake error

- The operator attempted to put the truck in motion while the parking brake was applied. Release the parking brake and try again.
- The truck has been put OFF with the parking brake released. Apply the parking brake.

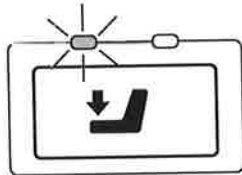

OPS error

The operator attempted to drive the truck without being correctly seated in the driving seat. Release the accelerator pedal, return all levers to their neutral positions and return to the seat, and try again.

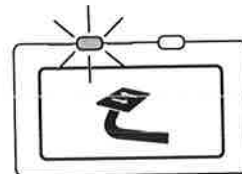

Drive errors

- The drive pedal was pressed during the start-up sequence. Repeat the start-up sequence correctly.

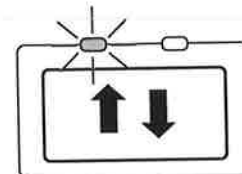

- The forward and reverse drive pedals (if present) were pressed simultaneously. Press one pedal only.

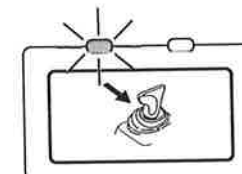

- The operator alighted from the truck with the direction lever engaged. Move the lever to neutral position.

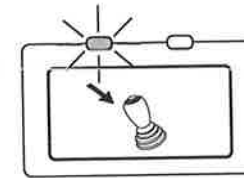

Lift error

- Load controls were operated during the start-up sequence. Repeat the start-up sequence correctly.
- Load controls were operated while the operator wasn't sitting correctly in the seat. Put controls in neutral, return to the seat, and try again.

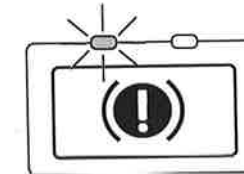

Brake system warning

The brake fluid level is low: call the Manufacturer's Service Centre.

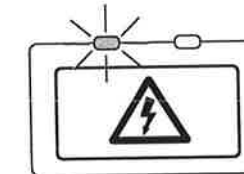

Voltage warning

There is a residual voltage into truck electric controls. Wait for the icon to come off. Meanwhile, do not open the battery hood.

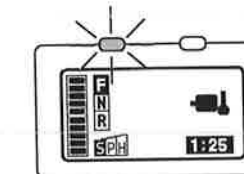

High temperature warning

The truck is overheating. In order to protect its devices, the truck can reduce its performance and stops if the work is prolonged.

When this warning goes on, it is recommended to stop work as soon as possible and park the truck, preferably in a fresh area away from direct sunlight, until the warning goes off.

A code indicates the overheated device.

PM: pump motor

DM: drive motor

PC: pump control

DC: drive control

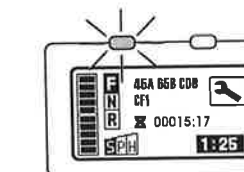

Unrecoverable error

All the other messages, indicated by an alphanumeric code.

Notice:

If the unrecoverable error message is shown, or if any other error message persists, call the Manufacturer's Service Centre.



OPERATOR MENU

Hour meter menu

Keep pressed the Hour meter button to access the Hour meter menu. Press the Hour meter button to change over the display in sequence.

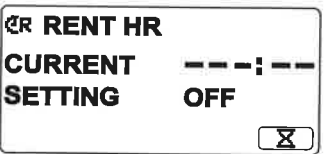
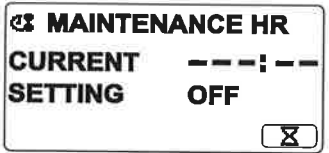
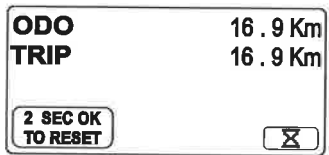
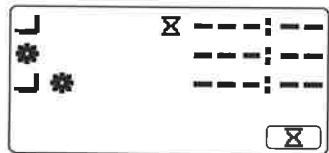
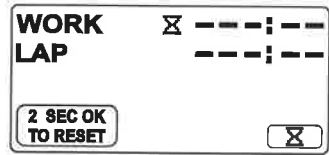

Key switch on hour meter (WORK)

It counts the time when the key switch is turned ON. (When logged on for models with PIN code entry system.)

Lap time meter (LAP)

It counts the time when the key switch is turned ON. (When logged on for models with PIN code entry system.) Keep OK button pressed for more than two seconds to reset the meter.

Pump motor service hour meter

It counts the time when the pump motor is activating on the power running mode for the material handling operations. (Not when the motor is activating only for the power steering).

Drive motor service hour meter

It counts the time when the drive motors are activating on the power running mode or regenerative brake mode. (Not when the drive motor is freewheeling).

Drive / pump motors service hour meter

It counts the time when the drive or pump motor are activating on the power running mode or regenerative brake mode. (Not either when the drive motor is freewheeling, or when the motor is activating only for the power steering).

Odometer (ODO)

It counts the traveling distance of the truck.

Trip meter (TRIP)

It counts the travel distance, and it can be reset. Keep OK button pressed for more than two seconds to reset the meter.

Planned maintenance hour meter

If this setting is ON, the preset service interval time and the current elapsed time are displayed.

Rent hour meter

If this setting is ON, the rent interval time and the current elapsed time are displayed.

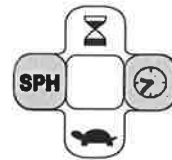
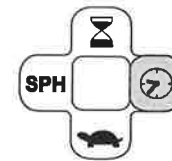

The material handling system and the drive motors can work simultaneously only if the hourmeter is enabled. The Manufacturer Service Centre can enable the hourmeter and restore the truck functionality.

En

Clock menu

Keep pressed the Clock button to access the Clock menu.

Clock and Power selection buttons allow to increase and decrease the value. Press OK button to confirm and proceed to following value, or OUT button to exit the menu.

Value sequence is:

Date: day / month / year (day of the week)

12h/24h visualization

Time: hours / minutes



Travel Setting menu

Keep pressed the Speed reduction button to access the Travel Setting menu.



Hour meter and Speed reduction buttons allow to select the item. Press OK button to confirm or OUT button to exit the menu.



Low speed

This menu allows to set the speed reduction mode. Clock and Power selection buttons allow to increase and decrease the low speed value. Press OK button to confirm or OUT button to exit the menu.



Speed alarm

This menu allows to enable a sound alarm when the truck speed exceeds a set value. Clock and Power selection buttons allow to increase and decrease the speed value. Press OK button to confirm or OUT button to exit the menu. If the speed is set to more than 50km/h, the low speed function is disabled: in that case "OFF" is displayed.

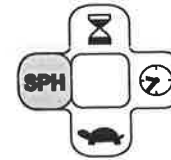

Power Control menu (OPT)

Keep pressed the Power selection button to access the Power Control menu.

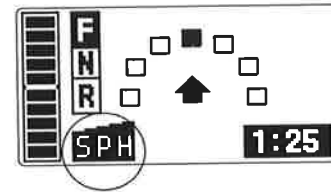

This menu allows to set the SPH power mode (custom) for Drive and Lift power settings.

Hour meter and Speed reduction buttons allow to select the item. Press OK button to confirm or OUT button to exit the menu.

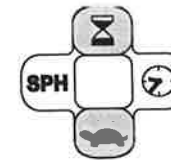

Drive power

This menu allows to set the truck speed and acceleration.

Lift power

This menu allows to set the material handling system speed and acceleration.

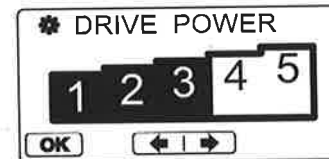

The procedure is the same both for drive and lift power settings.

Clock and Power selection buttons allow to increase and decrease the power value. Press OK button to confirm or OUT to exit the menu.



OTHER FUNCTIONS

PIN code entry system (OPT)

With this feature, the key switch is replaced with a ten-key pad (1) for PIN data entry.

Only operators who have registered PINs (Personal Identification Number) can activate the truck. PINs range from 1 to 5 figures.

The system has one non-erasable "INITIAL PIN" for emergency, set by administrators.

This system also can register ten different truck settings called "PROFILE", and each PIN can be assigned one setting out of the ten settings.

Notice:

PIN code entry is not an anti-theft security system.

- (1) LOGOFF switch
- (2) LOGIN switch

Login operation

The operator has to enter the PIN, and then press the login switch within 10 seconds, to activate the truck.

When each numerical key is pressed, the green LED lights and the buzzer sounds briefly.

The system checks the entered PIN to the registered PINs after pressing the login switch.

If the entered PIN is certificated, the buzzer sounds shortly, the green LED lights on and the truck activates.

The profile assigned by the PIN is loaded and the truck operates under the settings.

When the entered PIN is not certificated, the buzzer sounds longer and the system returns to the logoff state.

Pushing the logoff switch before completing entering a PIN reset the entered numbers and return the system to the logoff state.

Logoff operation

The operator can turn off the truck by pushing the log-off switch when the truck activates.

At that time, the system turns off the green LED, lights the red LED for one second, and the buzzer sounds briefly.

Leaving the truck without performing operations for a period of time (Auto power off setting) also turns it off automatically.

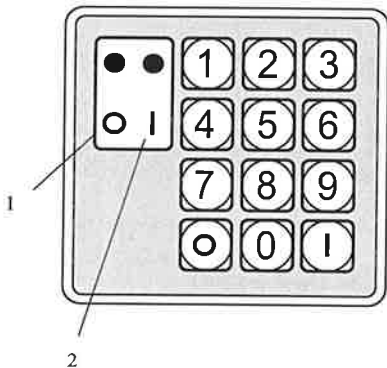
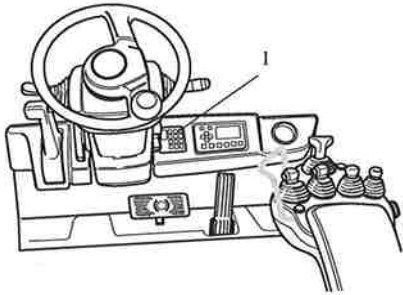

DHU (OPT)

The device is approved for use in GSM 900/1800 networks. The following safety precautions must always be followed during installation, operation, service and repair work.

If these safety precautions are not followed, it can result in a breach of the product's safety standards regarding design, manufacturing and intended area of use.

The manufacturer is not responsible for the consequences if these safety precautions are disregarded.

The device-unit emits radio waves when switched on.

Remember that interference can occur if it is used near TVs, radios, computers or equipment without adequate protection.

⚠ Warning

- Risk of interference in medical equipment.
DHU emits radio waves in the same way as cell phones and can therefore cause interference in medical equipment. Interference may result in patient safety being jeopardized.
If DHU is to be used near medical equipment, the same rules as for cell phones must be followed within the area concerned.
- Risk of fire or explosion.
DHU can cause sparks that can ignite inflammable chemicals. Do not use DHU in filling stations or close to fuel or other inflammable chemicals.
- Risk of unintentional detonation of explosives.
Radio waves from DHU can cause the unintentional detonation of explosives by primed detonators or similar being affected. The same rules that apply for radio transmitters must be followed in the proximity of blasting areas, which usually means that DHU must not be used there.
- Risk of personal injury or material damage.
There may be special areas where the radio waves from the DHU may cause unforeseen risks. If there are, in an area, special instructions for the use of radio transmitters, cell phones or suchlike, then these instructions must be followed.

DHU PIN code request

Prior to start the truck, the DHU requires to enter a PIN code by PIN keypad (see "PIN code entry system" chapter).

En



Shock sensor (OPT)

This feature detects and records intense shock on the truck.

If the detected shock exceeds the preset alarm value on either front-back or lateral direction while the truck is operating, the "Shock Alarm" icon and buzzer-sound alarm the operator.

Because only the administrator can cancel the buzzer sounds, the operator necessarily must report it to the administrator.

The detected shock values, date and time are recorded on the multi-function display at the moment of the detection. If "PIN code entry system" option is present, PIN is also recorded.

Notice:

- The strength of the shock generated on the truck depends on the objects where the truck collided. Not all of the collisions can be detected.
- The shock generated in the usual operation depends on the road conditions, the loads, and the material handling operations.
- All the detected records may not be necessarily based on a actual collision. Please investigate the records in consideration of the possibility of erroneous detections in the usual operation in addition to actual collisions.

If this setting is active, the Shock icon is shown on display when starting the truck.

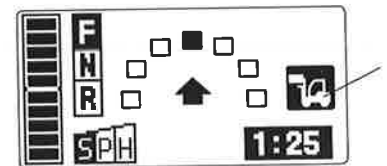
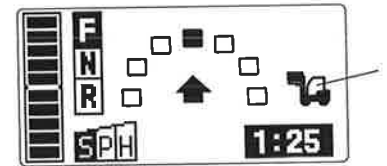
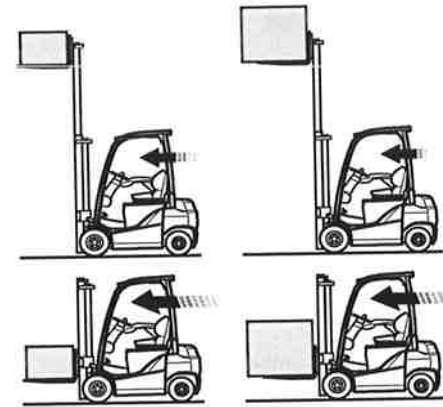
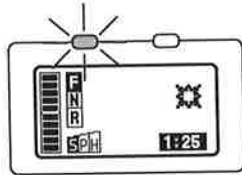

Auto speed control (OPT)

This function automatically limits acceleration, deceleration and maximum speed by detecting the forks height (Low/High) and the loaded weight, reducing the possibility of falling of loads.

⚠ Danger

- Safe driving is always necessary: Auto Speed Control helps against tip over risks but cannot prevent them.
- When loads are lifted to high position, never step on the accelerator pedal suddenly, or never shift the truck from the neutral to driving condition with keeping the accelerator pedal stepped on.

Notice:

Fluctuations of truck speed and acceleration can be caused by changes of road conditions.

Settings

This function can be enabled/disabled only by an administrator. When it is enabled, the Auto Speed Control indicator (1) is shown on display.

This function allows enable only acceleration / deceleration control, without limiting the maximum speed. In this case the Auto Speed Control indicator is shown with inverted colors (2).

Maximum speed is controlled in range from unlimited speed to approximately 8 km/h. If the speed reduction setting is active, the lowest one is taken as reference.

Deceleration limitation is disabled in the following cases:

- truck speed is less than 3 km/h
- the brake pedal is stepped in
- travel direction (forward/reverse) control is operated while traveling

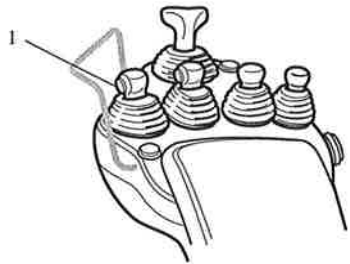

Load meter and Over set load alarm (OPT)

Load Meter

Keeping pressed the load display switch (1) on the lift lever switches the general screen to the load meter screen, displaying the load weight in unit of 0.01 t.

Weights less than 100 kg are displayed as 0.00 t.

Load meter screen doesn't appear while truck speed is detected.

Conditions for measuring

The mast should be vertical and the forks height should be at height of approximately 500 mm for measuring.

Notice:

- This function is not available for business dealings and certifications.
- It detects the lift cylinder pressure to facilitate measurements, so it should not be used to judge whether the overload value is near the allowable value.
- At the highest end, residual pressure is generated when the relief stops, and an overly large value is displayed.
- The accuracy may drop at high lift position (due to mast deflection and friction): in this case an arrow icon appears on load meter display.



Over set load alarm

An administrator can set the value to activate the "Over Set Load Alarm".

If the detected weight goes over the preset value when the operator is displaying the load meter by the load display switch, the lights of over load indicator and the buzzer sound inform the operator.

If a customer wishes the alarm to activate always, the technician can change it into such operation specification.

However in such operation specification, a lighter weight than the set value wrongly activates the alarm frequently because of fluctuations of load while driving, or because of increased load while lifting.

Notice:

This function should not be used to judge the allowable load.

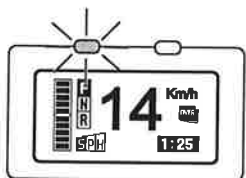

Height Selector (OPT)

This option consists of three functions that automatically stop the forks at the appropriate height as follows.

Maximum height limiter

The administrator can set a maximum height limit value. Subsequently, forks can never be raised over the height set by the operator.

Height limiter

The operator can set a maximum height value. Therefore, forks can't be raised over the height set.

The operator can enable/disable this feature by the height limiter switch.

Automatic height control

The operator can set up to three height favorite positions.

By pressing the automatic height control switch the operator can enable one of the favorite height positions; therefore, forks can't raised over that limit.

Notice:

If the Maximum Height Limiter or the Height Limiter is set, there is a case that the memorized positions of the Automatic Height Control are higher than the limited height by them. In this case the higher memory positions of Automatic Height Control are not displayed on the screen and cannot be selected. The height memories become available again after the Maximum height limiter or Height limiter is disabled.

Height Selector - Maximum height limiter

When the lift lever is operated upward and the forks reach the maximum height limiter position, the forks automatically stop there and buzzer sounds for a second.

If the lift lever is operated upward at the height where forks have already exceeded the maximum height limiter position, the forks never rise and the buzzer also sounds for a second.

Only the administrator can use the setting menu for "Maximum Height Limiter".

If this setting is active, the Maximum Height Limiter icon is shown on display when starting the truck.

En

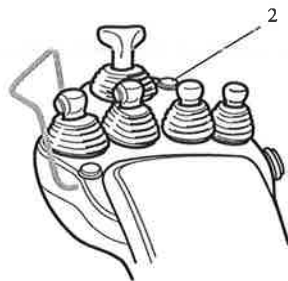

Height Selector - Height limiter

This feature allows to memorize a fork height position limit.

When the desired position is memorized and the height limiter switch (2) is pushed down, the feature is active, and the height limit indicator is shown on the display.

When the lift lever is operated upward and the forks reach the memorized height limiter position, the forks automatically stop there and buzzer sounds for a second.

It is possible to lift the forks up over memorized height limiter position by releasing the height limiter switch.

If the lift lever is operated upward at the height where forks have already exceeded the memorized height limiter position, the forks never rise up and the buzzer also sounds for a second.

To set the height position, access the Travel Setting menu. Use Clock and Power Selection buttons to select the Height Limiter menu.

Once selected, press OK button to confirm and access the setting.

Once in the menu, lift the mast to the desired fork position, then select "SET" (use Clock and Power Control buttons to select) and keep pressed OK for more than two seconds, until a "OK" message appears, confirming that the position has been memorized.

From now on, the height limiter is active.

Press OUT button to exit the menu.

To reset, access the Height Limiter menu, then select "CLR" (use Clock and Power Control buttons to select) and keep pressed OK for more than two seconds, until a "OK" message appears, confirming that the position has been reset.

From now on, the height limiter function is disabled until a new position is memorized.

Press OUT button to exit the menu.

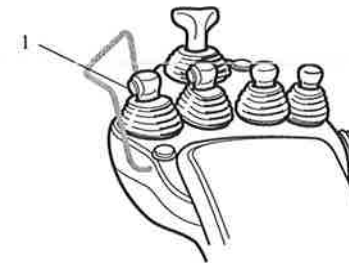
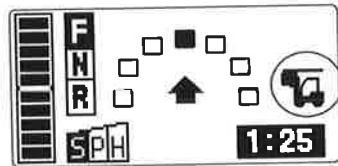

Height Selector - Automatic height control

This feature allows to memorize up to three favorite fork height positions.

A brief click of the load display switch (1) while the lift lever is at neutral show the assistant screen on display.

The order of the height memories is always displayed from lower to higher.

Counts of clicks and the selected target memory are related as follows.

1. lowest target
2. middle target
3. highest target
4. no target selection (count reset)

Operating the lift lever upward within 10 seconds will stop forks automatically at the selected target.

The number buzzer sounds informs the operator of the selected target height:

Lowest target: single brief buzzer sound (pi..pi..pi..)

Middle target: two brief buzzer sounds (pipi..pipi..pipi..)

Highest target: three brief buzzer sounds (pipipi..pipipi..pipipi..)

Notice:

- The first click always select the lowest target even if the forks height has already been over the lowest target position. So there is a constant relation between the number of clicks and memory selection.
- The target and the assistant screen are canceled if neither click nor lift-up operation is done over 10 seconds, or the lift lever is operated downward or returned to neutral position.
- When a limitation function of the material handling or the OPS function activates, all the function of the Height Selector (including the screen) are canceled. The movement of the mast is halted.
- When selecting a favorite height position lower than the current height, this feature prevent forks from moving upward. In this case, the buzzer sounds for a second, and the screen informs the operator of the invalid operation.

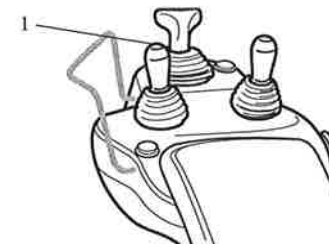
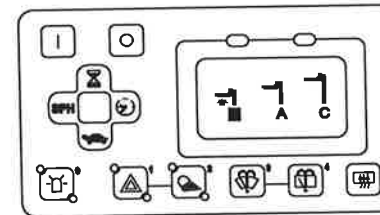

On joystick models, desired height can't be selected during tilting operations. Doing so activates the auto-leveling function.

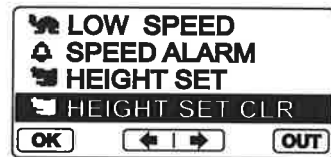
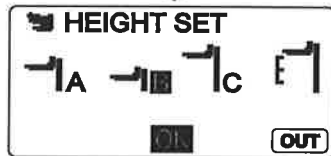
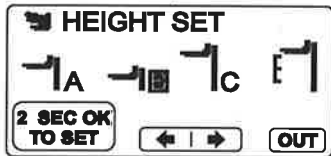
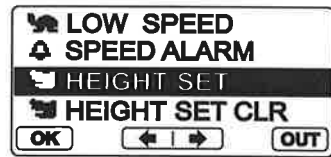

Setting

To memorize the height positions, access the Travel Setting menu. Use Clock and Power Selection buttons to select the Height Set menu.

Once selected, press OK to confirm and access the setting.

Operator must lift the forks up to the height that they want to memorize. At this time, the setting screen displays the height relation between three memories and the current height. So operators can select the memory to overwrite out of A, B or C by using Clock and Power Selection buttons.

Keeping OK button pressed for two seconds overwrites the current height on the selected memory.

If the memory has been overwritten, "OK" screen is displayed and the setting screen.

Press OUT button to exit menu.

Notice:

To memorize a height position, it's required a gap of at least 100mm (approx.) from other memorized heights.

All three memories can be cleared simultaneously.

The screen to clear all the memories is displayed by selecting the Height Set Clr menu in the Travel Setting menu. Keep OK button pressed for two seconds to clear all three memorized heights.

If the memories have been cleared, "OK" screen is displayed and the setting screen.

Press OUT button to exit menu.

Notice:

The height position memories of the height limiter and maximum height limiter cannot be cleared by this procedure.

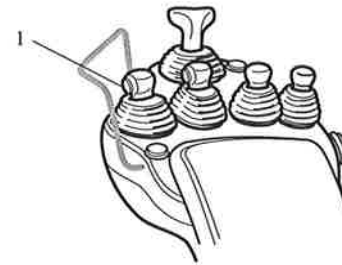

Automatic Height Control and Load Meter

If Height Selector and Load Meter options are both present, the load switch (1) plays two roles for Automatic Height Control selector switch and Load Meter switch.

A brief click on the load switch activates Automatic Height Control as usual; a longer push activates the Load Meter if the lift lever is in neutral position. Load Meter is not activated while the mast is lifting to height memorized by Automatic Height Control.

En



SWITCHES AND LEVERS

STEERING COLUMN

Key switch

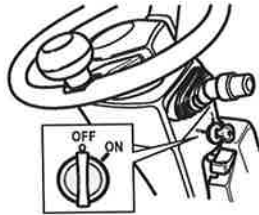

Insert the key with the teeth facing upward.

- OFFThe key can be inserted and pulled out in this position.
- 1 ONTurn the key in a clockwise direction from the OFF position. The truck is ready to start when the key is in this position.

⚠ Caution

- Be sure to sit in the seat before turning the key switch to ON. If the OPS indicator is displayed on the screen, release the accelerator pedal and return all levers to their neutral positions. Make sure that the OPS indicator goes off.
- Do not turn the key switch to ON while depressing the accelerator pedal.
- Remove the key switch when the truck is not in use.

Notice:

When the key switch is turned off, the forks will not lower even if the lift lever is shifted downward (Key-lift interlock).



Turn signal switch (OPT)

This switch causes the turn lights to blink.

Left turnpush the lever forward

Right turnpull the lever backward

The turn signals will operate even when the key switch is off. The turn signal switch returns automatically to the original position after a direction change.

Lights control switch (OPT)

This is two-stage turning switch.

The lights indicated by "○" in the table below light up at each turning position

Light name	Step 1	Step 2
Tail light (OPT)	○	○
Headlight (OPT)	—	○

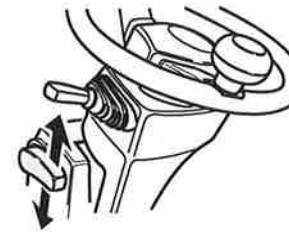
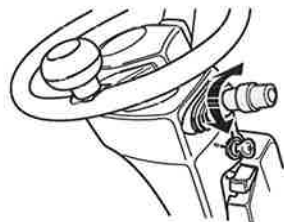

Tilt steering adjustment

The steering wheel position may be adjusted back and forth while the tilt steering adjust lever is raised.

Push the adjust lever up to fix the steering wheel at the adjusted position.

After the adjustment, try to move the steering wheel back and forth to make sure that it is locked into position.

⚠ Caution

Always adjust the steering wheel position before traveling. Never adjust the steering wheel position during traveling.

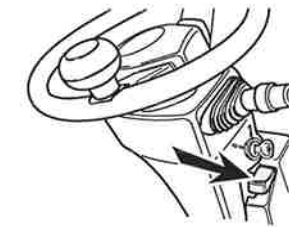

Steering Lock

The steering lock allows the steering column to tilt forward. It is different from the tilt steering adjustment, because the steering column can only be pulled back to the original position.

This is useful for operations like battery hood opening, when the operator needs to tilt forward the steering column, but wishes to keep the tilt adjustment for an optimal drive position.

Push the steering lock lever to unlock the steering column and tilt it forward.

Pull the steering column back until it clicks, locking in the original driving position.

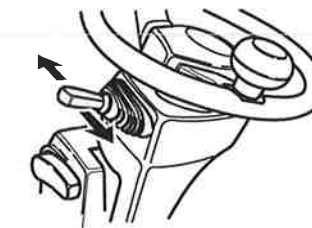

Travel direction lever (OPT) (models with single accelerator pedal only)

This lever selects forward or backward travel.

The neutral position is between the forward and backward positions.

Forward Push the lever forward

Backward Pull the lever backward

Push the lever in the direction opposite to the traveling direction, and depress the accelerator pedal to activate the electric brake for smooth braking.

⚠ Caution

- Stop the truck when shifting to forward or reverse. Perform this operation carefully when forks are loaded.
- If the OPS indicator is displayed on the screen, release the accelerator pedal, return all levers to their neutral positions and return to the seat.

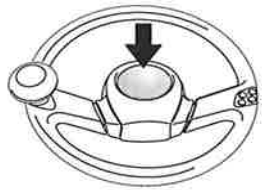

Horn button

Press the button in the center of the steering wheel to sound the horn.

ARMREST

Armrest position adjustment

Before operating the truck, adjust the armrest until the correct operating posture that matches that of the operator is reached.

1. Forward/backward position adjustment
Loosen the forward/backward position adjustment knob by pulling it up, then adjust the front and back positions. After adjusting, push the forward/backward position adjustment knob to fix it at its original position.
2. Height position adjustment
Loosen the height position adjustment knob in a clockwise direction and wiggle up and down to move.
3. Tilting position adjustment
Loosen the turn-lock lever by pulling it up, then adjust the tilting position. After adjusting, push the turn-lock lever to fix it at its original position.

⚠ Caution

- After adjusting the forward/backward, height and tilting positions of the armrest, be sure to confirm that the knobs and the lever are securely fixed. If the knob and lever become loose during operation, an operational mistake could occur.
- Do not adjust the position of the armrest during traveling or material handling operation.

Travel direction switch

To change the direction of travel, preselect forward or reverse travel by pressing the travel direction switch. The travel direction can also be changed when the fork lift truck is moving.

Forward Push the switch forward

Backward Push the switch backward

The travel direction is automatically put in neutral if the operator alights from the truck.



Mini-lever

Lift lever

Raises and lowers the forks, speed is controlled by the angle of the lever.

Raise Pull the lever

Lower Push the lever forward

Tilt lever

Tilts the mast forward and backward, speed is controlled by the angle of the lever.

Forward Push the lever forward

Backward Pull the lever

Attachment levers

These levers operate an attachment. Attachment speed is controlled by the angle of the levers.

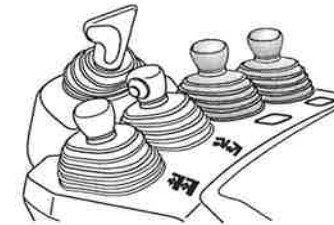
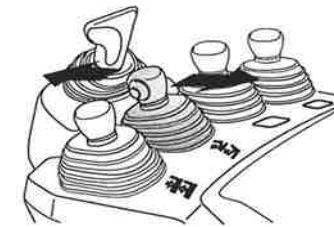

Joystick (OPT)

Load operating joystick

Lateral and push-pull operations correspond to lifting up/down and tilting, respectively.

Raise Operate the joystick rightward

Lower Operate the joystick leftward

Forward tilting Push the joystick

Backward tilting Pull the joystick

Operating in an oblique direction is possible for simultaneous lifting and tilting. Raising, lowering and tilting speed are controlled by the angle of the respective levers.



Attachment operating joystick

Lateral and push-pull operations correspond to the third and fourth mini-lever operations, respectively. Attachment speed is controlled by the angle of the levers.

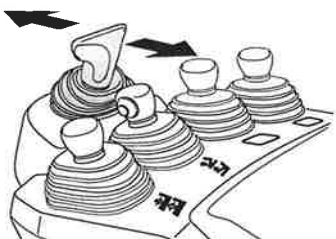
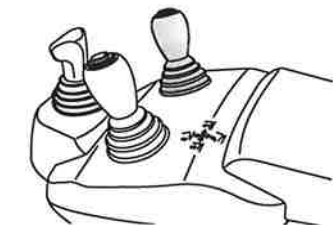

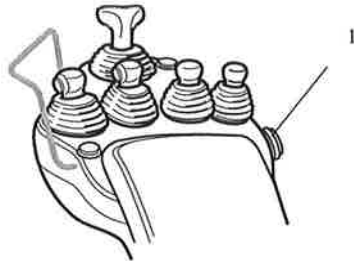

Emergency stop button (OPT)

In the event of an emergency, press the emergency stop button (1) to disconnect power and stop all truck movement (drive and lifting). Pull the button out again to reset it and restart work.

Notice:

Do not use the emergency stop button as a power switch to turn the forklift OFF.

PEDALS

Speed can be adjusted by the accelerator pedal depression.

Notice:

If the OPS indicator is displayed on the screen, return to the seat and release the accelerator pedal. Make sure that the OPS indicator is OFF.

⚠ Caution

- Apply the brakes carefully when the forks are loaded.
- Always release the accelerator pedal before applying brakes.
- Slow down before changing the forward/reverse traveling.

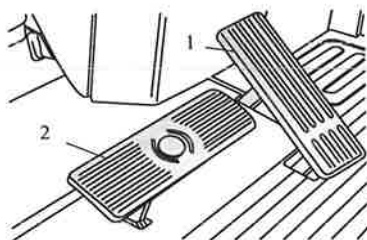

Single accelerator pedal

The accelerator pedal controls travel speed; travel direction is selected by direction lever or switch.

Traveling Step on the accelerator pedal (1)

Brake Step on the brake pedal (2)

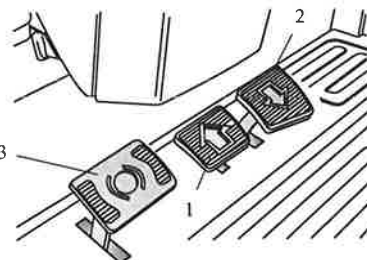

D2 pedal

The accelerator pedals select the forward/backward traveling and control travel speed.

Forward Step on the left accelerator pedal (1)

Backward Step on the right accelerator pedal (2)

Brake Step on the brake pedal (3)

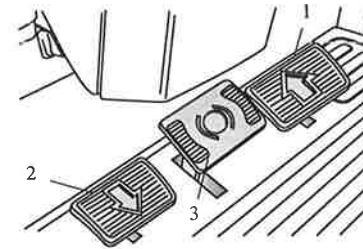

Double accel pedal (OPT)

This accelerator pedals select the forward/backward traveling and control travel speed.

Forward Step on the right traveling pedal (1)

Backward Step on the left traveling pedal (2)

Brake Step on the center pedal (3)

OTHER CONTROLS

Parking brake

⚠ Caution

- Be sure to depress the brake pedal when operating the parking brake.
- For safe parking operations, be sure to follow the parking procedure described in the Manual for Safe Operation.

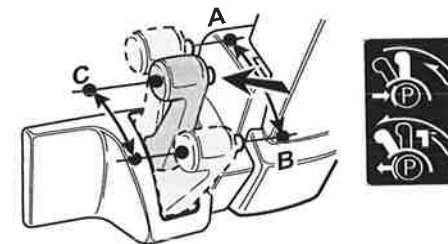

Lever model

To activate the brake, pull the lever to position B. When released, it returns to the parking position C. To release the brake, pull the lever once and keep the knob at the top of the lever grip pushed, to return the lever to the original position A.

Notice:

- When operating the lever, hold only the grip of the lever.
- If you fail to release the parking brake and travel, it may deteriorate the braking effect. Have the truck inspected at your dealer.

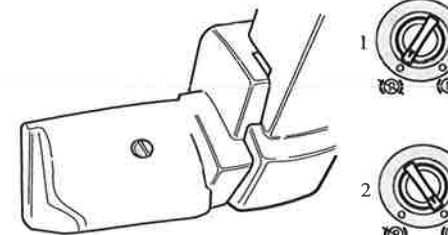

Switch model (OPT)

The switch in position OFF (1) enables the truck running. The switch in position ON (2) disables traction; the brake is locked.

⚠ Warning

Operation of the parking brake switch can cause the forklift truck to lock up immediately; use of the switch is therefore prohibited during normal operation of the truck.

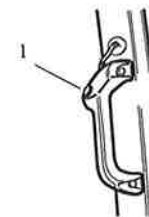

Rear assist grip with horn button (OPT)

The horn button (1) in the rear assist grip can be easily turned on when back running.



BODY COMPONENTS

Operator seat

The operator's seat and seat belt are provided for your safety. Get in the habit of using the seat belt whenever you sit on the trucks.

⚠ Warning

- The seat switch function prevents traveling and load handling operations when the operator is not seated in the seat. Be sure to remain seated in the seat while in operation. Do not operate the truck with any objects placed on the seat. This will cause the OPS system to operate abnormally.
- Do not turn on the seat switch by any method other than sitting on the seat.

The seat suspension mechanism provides a comfortable seating position based on the weight of the driver. The optimum driving position can be set using the following knob and levers.

- (1) Slide lever
Pull the slide lever to move the seat back and forth. The seat is locked in position when the lever is released.
- (2) Recliner adjust knob
Press the knob at the rear left to adjust the angle of the seat back.
- (3) Weight adjust knob
Turn the knob on the front right of the seat clockwise to adjust for a heavier body weight. Turn the knob counterclockwise to adjust for a lighter body weight.
- (4) Belt
- (5) Lumbar support knob (optional seat)
Turn the knob to adjust the lumbar support.
- (6) Adjustable backrest extension (optional seat)

⚠ Caution

- Always adjust your seating position before driving the truck. Sitting incorrectly in the seat will make the steering heavy.
- After adjustment, gently rock the seat forward and backward to confirm that the seat is firmly locked in position.

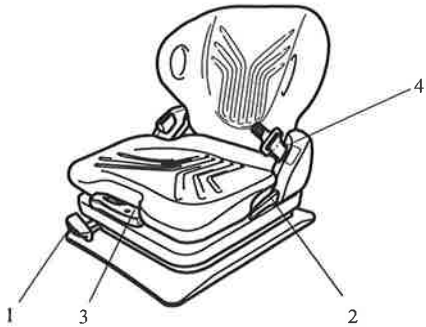

Standard seat

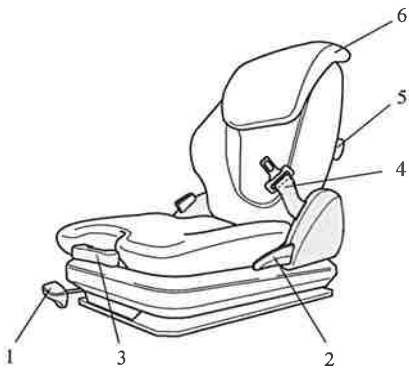

Optional seat



Seat pocket

A pocket for housing the Operator Manual and Manual for Safe Operation is provided on the rear side of the seat back. Push down the clip and pull the pocket to open it. If a manual is missing, be sure to ask your Service Centre for a copy.

Make sure the pocket is closed securely.

Notice:

The seat pocket is available for the standard seat model only.

Swivel seat (OPT)

This option can improve posture and the view during backward driving. Also it supports getting off, because it rotate to the left and it expands space wider between pillar and seat back.

Pull the lock release lever upward to swivel the seat.

Seat can returned to neutral position by pulling it.

⚠ Caution

While rotating the seat, do not put hands etc. in range of rotation.

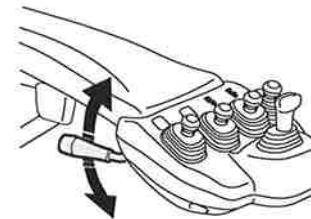

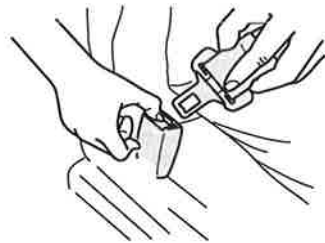

Seat belt

To fasten your seat belt, pull it out of the retractor and insert the tab into the buckle. You will hear a click when the tab locks into the buckle. Pull on the belt to make sure the buckle is securely latched. The seat belt length automatically adjusts to your size. To release, push the release button and allow the belt to retract.

Notice:

If the seat belt is locked and cannot be drawn out any further, pull on the belt strongly once, then loosen it, then draw it back out slowly.

⚠ Warning

- Always fasten the seat belt during operation.
- Your seat and seat belt will reduce the risk of serious injury or death in case of a truck tip over. In a tip over, danger of serious injury or death is reduced if you stay with the truck in the operator's compartment.
- Be sure to read the Manual for Safe Operation about residual risks of tip over.

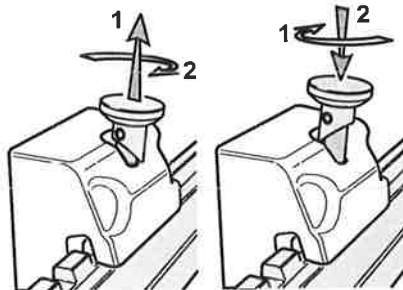

Forks

Lift each fork stopper and unlock so that the forks can be shifted left and right. Adjust the forks in the position most appropriate for the load. When adjusting the forks, make sure that the center of gravity of the load corresponds to the center of the truck. After adjustment, turn the stoppers to lock the forks in place.

Draw bar

The draw bar is located at the back of the counterweight, and is used to pull the truck out if its tyres drop into a gutter or become stuck in mud. The draw bar can also be used for loading the forklift onto another truck or truck. Never use the draw bar for towing the truck.

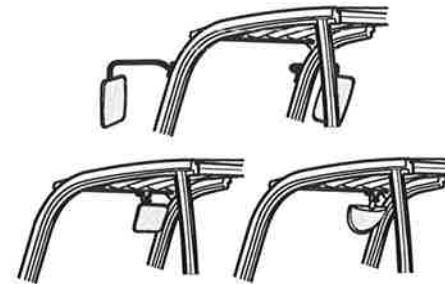

Rear view mirrors (OPT)

Set mirror angles before truck start.

⚠ Warning

Do not rely only on mirrors while traveling backward.



Heater (OPT)

Turn the fan switch (1) clockwise to start up the heater and set the fan speed.

There are four available positions:

OFF, moderate speed, medium speed, high speed.

Turn the heat switch (2) clockwise to set the temperature. There are three available positions:

moderate heat, medium heat, high heat.

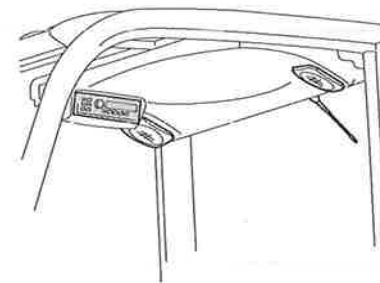

Sound system (OPT)

Refer to the system's manufacturer manual.

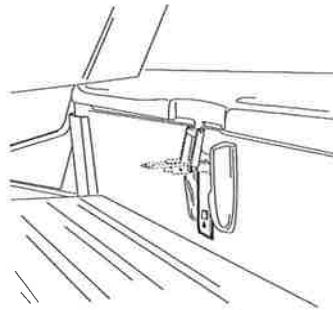

Battery hood

⚠ Warning

Before opening the battery hood, make sure that the truck is OFF, and the mast is in vertical position with forks lowered.

Opening

1. Tilt the steering column forward to the foremost position (through steering column lock lever).
2. Move the armrest back to the backmost position. Push the armrest down at the downmost position.
3. Slide the armrest up.
4. Unlock the battery hood catch by pulling up the catch button, then pull up the catch.
5. Fully open the battery hood by his grip.

Closing

Push down the battery hood and secure it by his catch. When closing the hood, make sure that the battery cables are kept in their correct position.

⚠ Warning

Be sure to check that battery hood is firmly locked before operating the truck.

Side hood

To remove the battery side hood, it is necessary to open the battery hood first; then pull the side hood upward.

Battery plug

The plug connects the battery to each electric device. Before disconnecting or connecting the plug, make sure the truck is OFF. Always keep the battery plug connected unless it is necessary to disconnect it.

⚠ Caution

- Disconnect the battery plug before inspecting the electrical systems.
- Do not disconnect the battery plug during current conduction as it may cause arcing or plug damage.
- When disconnecting the battery, pull the battery plug by his handle. Don't pull the cables.

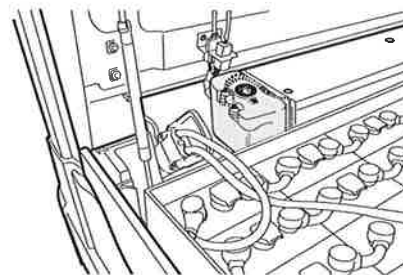
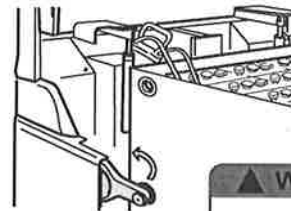
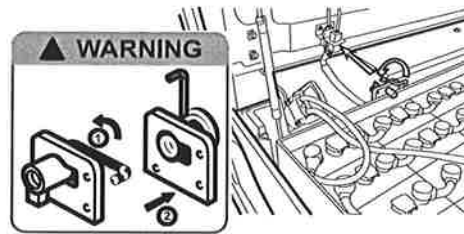

Battery stopper

To unlock the battery stopper, pull the handle upward and then push the stopper over the battery case.

Follow the reverse procedure to lock it.

⚠ Warning

Always keep the battery stopper locked unless it is necessary to unlock it.

En

Battery side stopper (OPT)

To unlock the battery side stopper, loosen the screw and pull the stopper upward, and then tighten the screw to prevent the stopper to interfere with the battery.

Follow the reverse procedure to lock it.

⚠ Warning

Always keep the battery stopper locked unless it is necessary to unlock it.

Wiper washer tank (OPT)

To replenish, open the tank cap. The tank can be filled up to cap level.

Notice:

While filling, do not spill the liquid outside the tank.



Cabin (OPT)

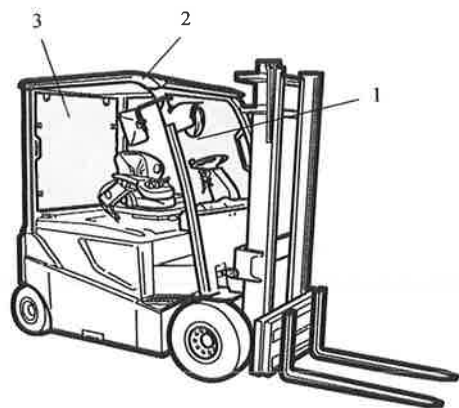

Half cabin

- (1) Windshield
- (2) Roof
- (3) Tailgate

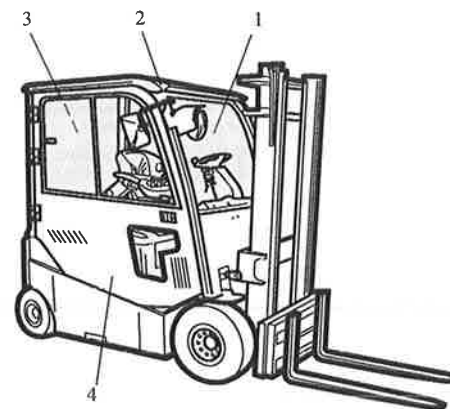

Full cabin

- (1) Windshield
- (2) Roof
- (3) Tailgate
- (4) Side door

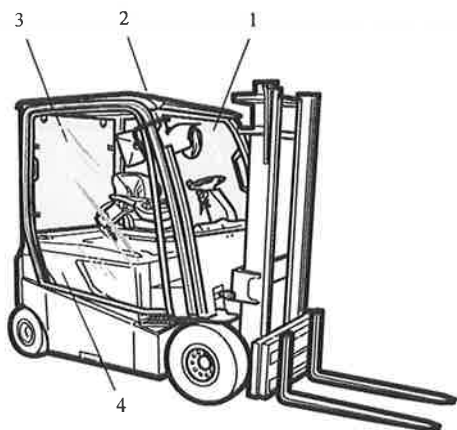

Canvas cabin

- (1) Windshield
- (2) Roof
- (3) Tailgate
- (4) Canvas door



PRE-OPERATION CHECK

Item	Inspection
Previously detected malfunctions	Correct.
Exterior	Truck posture; oil leakage; water leakage; loose sections; exterior damage.
Wheels	Wear or damage; rims; hub nuts.
Lights	Light condition; cracked.
Brake pedal	Braking action.
Parking brake	Braking action.
Steering wheel	Looseness; play; vibration; pulling.
Horn	Sound.
Instruments	Functioning.
Material handling system	Function of each section; oil leakage; cracking; looseness.
Motor	Abnormal noise; rotation.
Battery	Charging.
Seat belt	Cuts, frays; deck latch and buckle condition.
Static strap (if present)	Integrity

Pre-operation checks are the responsibility of the forklift user. Be sure to perform a pre-operation check before beginning work to insure safe and comfortable operation.

⚠ Warning

If any abnormality is found, or an unrecoverable error code appears on the display, stop operation immediately and have the truck inspected at the Manufacturer's Service Centre.

WALKAROUND INSPECTION

Truck posture

Does the truck excessively lean to one side or the other? If so, check for a flat tyre puncture or problem with the undercarriage.

Beneath the truck

Check for any oil or water leakage on the ground or floor where the truck was parked. Check for loose sections or damage.

If anything unusual is found, have the truck inspected at the Manufacturer's Service Centre.

Lights inspection

Notice:

Some devices are OPT.

Make sure that the filament is not damaged and inspect the lens.

Always keep the lenses clean to insure proper forward vision.

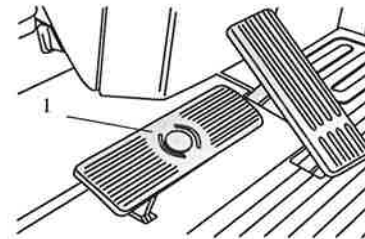
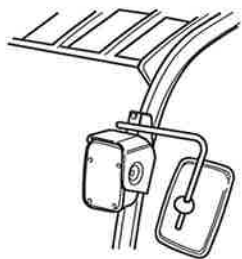

ON BOARD TRUCK INSPECTION

Brake pedal inspection

1. Depress the brake pedal (1) fully, and check that a sufficient reaction can be felt.
2. When the pedal is kept depressed, make sure that it does not sink any further.
3. Also check that no abnormality of pedal depression and return movement is observed.
4. If abnormality of pedal depression is found, have the truck inspected at the Manufacturer's Service Centre.

Parking brake inspection

Check if the parking brake can be correctly put on and off. If an abnormality is found, have the truck inspected at the Manufacturer's Service Centre.

OPS indicator inspection

Sit in the seat, and turn ON the truck. Make sure that the OPS indicator is not displayed on the screen.

⚠ Warning

In any of the following cases, stop operation and have the truck inspected at the Manufacturer's Service Centre:

- The OPS indicator is not displayed on the screen when the operator leaves the seat.
- The OPS indicator does not turn OFF when the operator returns to the seat.

Inspection of measuring instruments

Measuring instruments are indispensable for understanding the truck status during operation. Turn ON the truck to check the normal functioning of each instrument.

Battery charge inspection

1. Perform the inspection after turning ON the truck.
2. Check the battery discharge indicator on the display to see if the battery charge is sufficient.

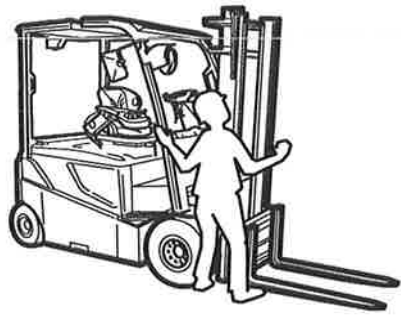

Load handling system inspection

1. Check the forks for the installation position, cracks and bending.
2. Check for mast distortion, chain tension and oil leakage from cylinders and piping.
3. Operate the load controls to check their functioning.

Notice:

- Be sure to perform full-stroke operation for each cylinder piston a few times before starting daily operation.
- New trucks can temporarily experience frictions that may result in a lock of the fork carriage while lowering. In this case, it is enough to briefly lift the fork carriage to unlock it.
- If any abnormality is found, have the truck inspected at the Manufacturer's Service Centre.

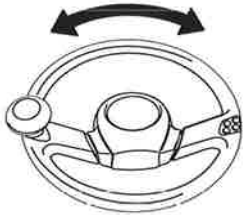

Steering wheel inspection

1. Perform the inspection after turning ON the truck.
2. Check the steering wheel play after setting the rear wheels in the straight travel position.
3. Turn the steering wheel and move it up and down to check that there is no looseness.
4. If any abnormality is found, have the truck inspected at the Manufacturer's Service Centre.

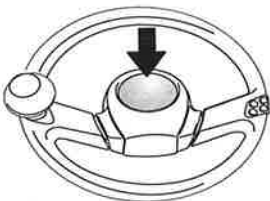

Horn inspection

Press the horn button to see that the horn sounds normally.

Full cabin (OPT) inspection

Check:

1. Correct operation of the doors.
2. Correct operation of the gas struts that hold open the doors.
3. Perfect condition of the locks, hinges, doors and the gas struts.

WHILE TRAVELING SLOWLY

Brake performance

Depress the brake pedal, and see if there is any abnormality in braking performance or if the brake is applied only on one side. Activate the parking brake to see that the truck is stopped and that the parked position is maintained.

Motor inspection

Drive the truck to check the motor for smooth running without any abnormal noise. Also operate the load controls to check the pump motor.

Steering system inspection

While moving the truck slowly in a safe location, turn the steering wheel to the left and right and check for any unusual movement.

Load handling system inspection

Check the mast to make sure that it can be properly tilted forward and backward and raised up.

BEFORE GARAGING THE truck

Remove dirt and powder from all truck components and then perform the following:

1. Inspect for oil or water leakage.
2. Inspect each component for warping, scratches, dents, or cracks.
3. Lubricate each component, if required.
4. Fully raise and lower the forks to lubricate the inside of the lift cylinder.
5. If you sense anything unusual during operation, notify your supervisor.

⚠ Warning

Do not operate the truck until repairs have been completed.



SELF SERVICING

Item	Inspection
Battery	Level check; distilled water addition; specific gravity check
Hydraulic oil	Oil level; contamination; viscosity
Tyres	Condition; tread wear; pressure (for pneumatic tyres)
Mast and steering linkage	Greasing MP grease
Chain lubrication	Engine oil
Bolts and nuts	Retightening
Electric fan filter and convoyer (if present)	Cleaning
Swing lock cylinder	Greasing MP grease

Self Servicing Table

Self maintenance is responsibility of the forklift user, and must performed weekly or every 40 hours of truck operations, whichever comes first.

Never fail to perform self maintenance to maintain safe, comfortable operation.

Maintenance required consists mainly in checking and addition, as shown in the "Self servicing table". As oil or grease needs periodic replacement depending on the degree of contamination, take proper action as required.

Have necessary adjustments and replacements performed at the Manufacturer's Service Centre.

⚠ Warning

Please always refer to the Manual for Safe Operation.

⚠ Caution

In case of truck inactivity for a period longer than a week, perform these operations once a week:

- Fully raise and lower the forks to lubricate the inside of the lift cylinder.
- Slowly perform forward and reverse truck translation, for at least 10 m in each direction.

Battery electrolyte level inspection

When checking the electrolyte, make sure the truck is on a flat surface and carrying no load before removing the battery.

⚠ Caution

Always perform this operation after the battery has been fully charged.

Hydraulic oil level inspection

Park the truck on a level surface and lower the forks to the ground before checking the level of the hydraulic oil.

1. Remove the footboard.
2. Wipe the level gauge attached to the oil cap with clean cloth, and insert it again into the tank.
3. Extract the level gauge gently and check that the oil adhesion is up to the level line.
4. If the oil level is insufficient, add oil. Spilled or splashed oil must be wiped off thoroughly.

Notice:

The oil level must be checked with the oil cap in contact with the retainer inlet.

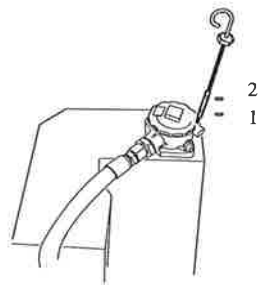

- (1) 2.0 - 2.5 tons oil level
(2) 3.0 - 3.5 tons oil level

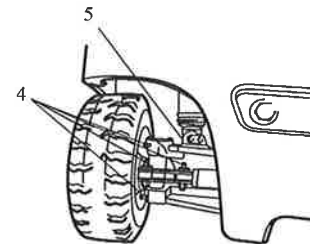
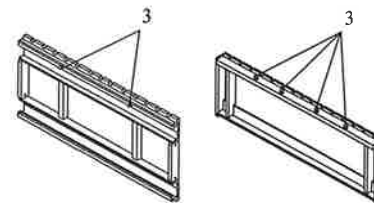
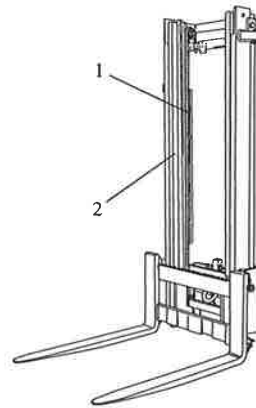

Greasing mast and steering linkage

Sufficiently grease when required:

Mast:

Chains (1) and pads guides (2).

Sideshifter (OPT):

Clean the upper grease fitting tips (3) thoroughly before greasing. After greasing, wipe off excess grease.

Rear wheels bearings:

Clean the four grease fitting tips (4) of each wheel thoroughly before greasing. After greasing, wipe off excess grease.

Swing lock cylinder:

Clean the fitting tip (5) thoroughly before greasing. After greasing, wipe off excess grease.

(The fitting tip is located in the rear of the swing lock base, and can be reached by left side).

Tyre tread inspection

Check the tyre tread wear and condition. The wear limit can vary according to tyre's manufacturer specifications.

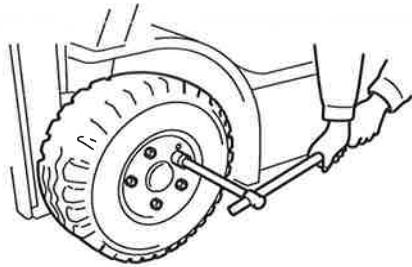

Retightening of bolts and nuts

Retighten the bolts and nuts of: drive units, counter-weight, overhead guard, wheels, rear axle, mast. Refer to Service Data for proper torque.

Battery charging

When the truck is to be withdrawn from use for two weeks or longer, all batteries should be fully charged and stored with the battery plug disconnected to avoid battery discharge. When the truck is to be stored for a further period, the battery should be charged regularly once every month.

Battery replacement

⚠ Caution

Turn the truck OFF before disconnecting or connecting the plugs.

Standard model

1. Open the overhead guard hatch.
2. Open the battery hood (see "Battery hood" chapter).
3. Disconnect the battery plug.
4. Remove the side hood.
5. Unlock the battery stopper.
6. Attach a hanger to the battery case and remove with a hoist.

⚠ Warning

Use fiber belt, chain or wire cable designed for lifting purposes which is sufficiently strong.

Overhead guard hatch

The overhead guard hatch must stay firmly closed during normal operations. However it's necessary to open it in order to replace the battery with a hanger.

To open, pull down the knob and unlock by rotating it; then pull up the hatch.

To close, pull down the hatch by his grip, then pull down the knob and lock by rotating it.

⚠ Warning

Never use different means and operations to open and close the hatch, other than those described above.

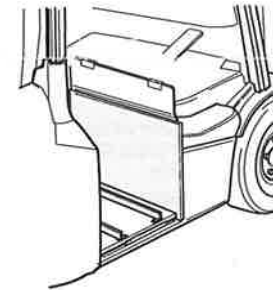
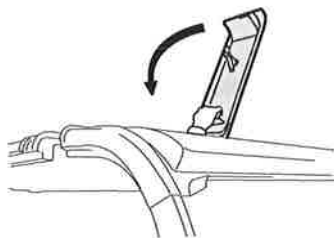
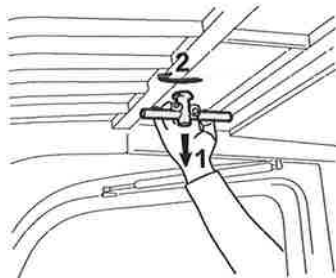
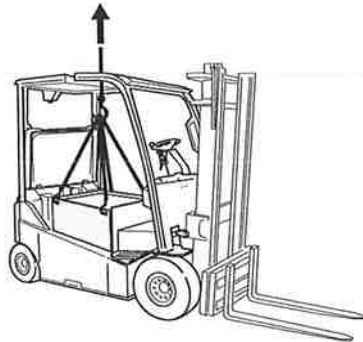

Low Lift-Out model (OPT)

Roll-out (Slide-Out) model (OPT)

⚠ Caution

Turn the truck OFF before disconnecting or connecting the plugs.

1. Open the overhead guard hatch.
2. Open the battery hood (see "Battery hood" chapter).
3. Disconnect the battery plug.
4. Remove the side hood.
5. Unlock the battery stopper.
6. Unlock the battery side stopper.
7. Attach a hanger to the battery case and remove with a hoist.

⚠ Warning

Use fiber belt, chain or wire cable designed for lifting purposes which is sufficiently strong.

Side-Out model with fork pockets (OPT)

1. Open the battery hood (see "Battery hood" chapter).
2. Disconnect the battery plug.
3. Remove the side hood.
4. Unlock the battery stopper.
5. Unlock the battery side stopper.
6. Replace the battery case by lifting and pulling the battery tray with another forklift truck.

⚠ Caution

Check that the edge side of the battery tray doesn't go out of the battery.



Tyre replacement

Front wheels

1. Park the truck on a level surface.
2. Apply the parking brake and chock the wheels.
3. Tilt the mast backward, raise the forks by about one meter, and insert the jack under the chassis, near the front wheels.
4. Jack up the truck until the tyres are about to leave the ground and loosen the hub nuts (1).
5. Jack up the truck until the tyres leave the ground. Remove the hub nut and wheel.
6. To reinstall each wheel after replacing the tyre or repairing flat tyres, operate in the reverse order of the procedure for removal. The hub nuts should be tightened evenly in the sequence shown in the figure. See the service data for the hub nut tightening torque.
7. Repeatedly drive forward and backward 2 to 3 times and check for looseness of hub nuts; if necessary, retighten the nuts.

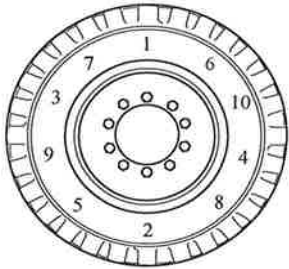

Rear wheels

1. Park the truck on a level surface.
2. Apply the parking brake and chock the wheels.
3. Insert the jack under the chassis, near the rear wheels.
4. Jack up the truck until the tyres are about to leave the ground and loosen the hub nuts.
5. Jack up the truck until the tyres leave the ground. Remove the hub nut and wheel.
6. To reinstall each wheel after replacing or repairing the tyres, operate in the reverse order of the procedure for removal. The hub nuts should be tightened in the same sequence as that for the front wheels. See the service data for the hub nut tightening torque.
7. Repeatedly drive forward and backward 2 to 3 times and check for looseness of hub nuts; if necessary, retighten the nuts.

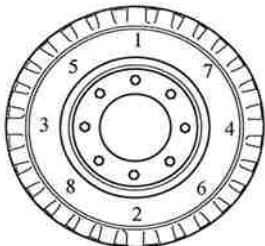

⚠ Warning

- After jacking up the truck, never enter the area under the forks and frame. Serious injury may occur if the jack happens to be removed accidentally.
- Use a jack which is sufficiently strong.

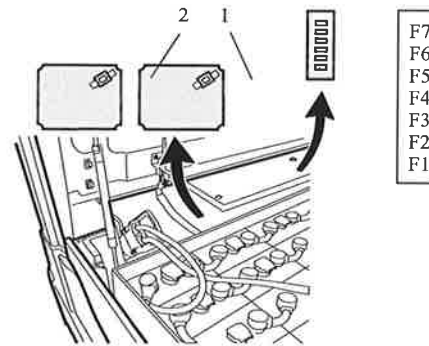

F7
F6
F5
F4
F3
F2
F1

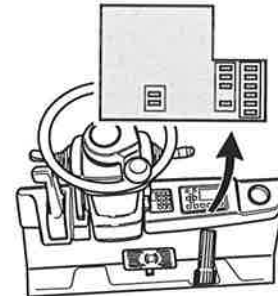

F14
F18
F8
F12
F19
F13
F20
F15
F9
F16
F17

Fuse replacement

When lights do not light or electrical system devices do not function, the respective fuse may be blown.

The 80 V fuses are located near the controls rear compartment.

The Drive (1) and Lift (2) Power Fuses are located on the respective controls.

To access them, open the battery hood, then remove the rear cover.

The 24 V fuses are located under the dashboard, on the right.

To access them, remove the cover on the right side of the truck.

Notice:

- Always replace with a fuse with the same capacity. For fuses assignment and capacity see Service Data chapter.
- If the new fuse is blown immediately after replacement, ask the Manufacturer's Service Centre for inspection.

Hoisting method

When hoisting the truck, use the lifting holes near the top of the mast for the front side, and the marked hooking points for the rear position, as shown in the illustration.

⚠ Danger

Use fiber belt or wire cable designed for lifting purposes which is sufficiently strong.





PERIODIC MAINTENANCE

Periodic inspection and maintenance are necessary to keep your forklift truck running smoothly, and must be performed by specialized technicians: ask your Dealer Service Centre.

Only manufacturer's genuine spare parts can guarantee maintenance of the safety levels and complete compatibility with other parts on the truck.

Maintenance intervals refer to normal use of standard truck versions and are based on total operating hours, or months of truck life cycle, whichever comes first (i.e. most inspections are scheduled every 1000 operating hours, or at least every six months).

Trucks operating under multi-shift work conditions must reduce intervals by:

- 15% for 2 daily shifts
- 30% for 3 daily shifts

Periodic maintenance for trucks in storage is reported in the Manual for Safe Operations.

Inspection method:

- I:** Inspect, correct and replace as required
- M:** Measure and correct, and adjust as required
- T:** Tighten
- C:** Clean

(*) New trucks: 6 weeks / 250h inspections are referred to new trucks only (whether under multi-shifts or not).

Periodic Replacement Table

REPLACEMENT CYCLE (Based on total operating hours or months of truck life cycle, whichever comes first)	every	6 weeks	12	30	60	months
	every	250	2000	5000	10000	hours
Drive unit oil		•*	•			
Hydraulic oil			•			
Hydraulic oil filter		•*	•			
Oil tank breather filter			•			
Brake fluid			•			
Tilt cylinder hydraulic hoses				•		
Steering system hoses				•		
High pressure hydraulic hoses					•	
Lifting chains					•	
Chain securing tie rods					•	
Swing lock cylinder					•	

Periodic Maintenance Table

MAINTENANCE CYCLE (Based on total operating hours or months of truck life cycle, whichever comes first)	every	6 weeks	6	12	months
	every	250	1000	2000	hours
DRIVE SYSTEM					
Wheels					
Tyre cuts, damage or uneven treads			I		←
Metal chips, pebbles or other foreign matter trapped in tyre tread		I*, C*	I, C		←
Tread depth		I*	I		←
Tyre pressure (pneumatic tyres)		M*	M		←
Hub nut tightening torque		T*	T		←
Rim side ring and disc wheel integrity		I*	I		←
Front and rear wheel bearing abnormal noise and fastening		I*	I		←
Front axle					
Body deformation and damage					I
Body to frame fastening			I		←
Abnormal noise and fastening			I		←
Rear axle					
Body deformation and damage					I
Body to frame fastening			I		←
Abnormal noise and fastening			I		←
Axle beam fastening in truck longitudinal direction		I*	I		←
Hub play		I*	I		←
Mechanical end stroke			I		←
Steering cylinders leakage (if present)		I*	I		←
Steering cylinders integrity and deformation (if present)			I		←
Steering cylinders tightening torque (if present)			I		←
Steering king pin (if present)			I		←
Linkages play (if present)			I		←
POWER TRANSMISSION SYSTEM					
Drive unit					
General condition, integrity, cleaning				I, C	←
Oil leakage			I		←
Oil level and status		I*	I		←
Bolts and nuts fastening				I	←
Motor to transmission fixing bolts tightening torque			T		←
Drive unit to frame fixing bolts tightening torque			T		←
Oil screw plugs cleaning and tightening			C, T		←
Air breazer condition and cleaning			I, C		←
S.A.S.					
Operation			I		←
Sensor fittings and wire harnesses integrity and fastening			I		←
Functional parts and loose mountings integrity, deformation, oil leakage			I		←
Swing lock cylinder and / or accumulator performance			I		←
Load sensor condition			I		←



MAINTENANCE CYCLE (Based on total operating hours or months of truck life cycle, whichever comes first)	every	6 weeks	6	12	months
	every	250	1000	2000	hours
ELECTRICAL SYSTEM					
General					
Truck insulation			I		←
Static strap integrity (if present)			I		←
Motor					
Cleaning			I, C		←
Fastening			I		←
Rotation sound			I		←
Insulation resistance			I		←
Power cables tightening torque			T		←
Battery					
Abnormality in upper portion of the battery and / or the case			I		←
Presence of spilled liquid inside the case			I, C		←
Plug status and cleaning			I, C		←
Power cables status			I		←
Terminal cleaning and fastening			I, C		←
Insulation resistance			I		←
Charging level			I		←
Electrolyte level			I		←
Electrolyte specific gravity			M		←
Voltage measurement of each battery cell after charging				M	
Magnetic switch - Contactors					
Contacts integrity, cleaning, fastening			I		←
Auxiliary contact operating condition, integrity, cleaning			I, C		←
Arc shooter mounting condition (if present)			I		←
Coil mounting locations fastening			I		←
Main circuit lead wire mounting condition and fastening			I		←
Connected cables tightening torque			T		←
Function test of all equipments connected			I		←
Microswitch - Potentiometers					
Installation integrity and fastening			I		←
Operating condition and timings			I		←
Accelerator and brake pedals potentiometers operating condition			I		←
Armrest levers potentiometer operating condition (if present)			I		←
Direction switch (if present)					
Integrity and operating condition			I		←
Wiring connections			I		←
Controller					
Integrity, cleaning and operating condition			I, C		←
Presence of alarms in the logbook			I		←
Connected power cables tightening torque			T		←
Wiring connections			I		←
Connector status			I		←
Case cleaning (with compressed air)			C		←
Electric fan functionality (if present)			I		←
Electric fan filter and convoyer cleaning (if present)			C		←

MAINTENANCE CYCLE (Based on total operating hours or months of truck life cycle, whichever comes first)	every	6 weeks	6	12	months
	every	250	1000	2000	hours
Fuses and Relays					
Wiring fastening			I		←
Functionality of all functions protected by fuses and relays			I		←
Wiring					
Harness condition, integrity, fastening			I		←
Wire harness coating integrity			I		←
Connections fastening and taping condition			I		←
STEERING SYSTEM					
Steering wheel					
Play and fastening		I*	I		←
Steering valve					
Oil leakage		I*	I		←
Mounting fastening		I*	I		←
Max pressure			M		←
Steering system					
Steering angle to right and left				I	
Power steering - Hydraulic steering motor (if present)					
Oil leakage			I		←
Power steering hose integrity				I	
BRAKING SYSTEM					
General					
Brake liquid/ oil level (if present)			I		←
Liquid / oil leakages (if present)			I		←
Brake system bleeding (if present)			I		←
Low fluid level warning light (if present)				I	
Brake pedal					
Braking performance			I		←
Pedal stroke and play			I		←
Return stroke			I		←
Linkages		I*	I		←
Parking brake					
Braking performance			I		←
Lever pull margin and operating force (if present)			I		←
Parking switch operation (if present)			I		←
Magnetic discs play, wear and cleaning (if present)			I		←
Brake discs					
Disc wear and damage				I	



MAINTENANCE CYCLE (Based on total operating hours or months of truck life cycle, whichever comes first)	every	6 weeks	6	12	months
	every	250	1000	2000	hours
MATERIAL HANDLING SYSTEM					
Forks					
Forks and stopper pins integrity and wear			I		←
Alignment between left and right fork fingers			I		←
Fork heels wear			I		←
Welded portions cracking			I		←
Mast and lift bracket					
Welded portions deformation, damage, cracking			I		←
Roller rotating condition, wear, damage			I		←
Mast support bushing wear and damage			I		←
Mast pads adjustment, wear, damage			I		←
Roller pin wear and damage			I		←
Mast and lift bracket fastening			I		←
Fork carriage side, lower and upper pads condition		I*	I		←
Chains and chain wheels					
Chain tension deformation, damage, slackness		I*	I		←
Chain lubrication			I		←
Chain anchoring devices abnormality			I		←
Chain wheel wear and damage			I		←
Chain wheel revolution			I		←
Attachment (if present)					
Abnormalities and mounting condition			I		←
HYDRAULIC SYSTEM					
Cylinders					
Oil leakage			I		←
Rod and rod end integrity, deformation, fastening			I		←
Tilt cylinders mounting integrity, fastening, operating condition			I		←
Natural drop, natural forward tilt			I		←
Mast cylinders mounting integrity and fastening			I		←
Lifting and lowering speed			I		←
Uneven movement			I		←
Hydraulic pump					
Oil leakage and abnormal noise			I		←
Hydraulic oil tank					
Oil leakage			I		←
Oil level and contamination			I		←
Tank and oil strainer condition			I		←
Hydraulic filter					
Cleaning				C	
Control levers (if present)					
Operating condition			I		←
Oil control valve					
Oil leakage			I		←
Safety valve function			I		←
Relief pressure measurement				M	

MAINTENANCE CYCLE (Based on total operating hours or months of truck life cycle, whichever comes first)	every	6 weeks	6	12	months
	every	250	1000	2000	hours
Hydraulic hose and piping					
Oil leakage			I		←
Deformation and damage			I		←
Linkage fastening			I		←
SAFETY DEVICES, etc.					
Body					
Frame, cross member, etc. damage and cracking					I
Bolts and nuts fastening					I
Overhead guard					
Integrity			I		←
Welded portions cracking			I		←
Backrest					
Deterioration, damage, cracking			I		←
Mounting parts fastening			I		←
Seat					
Mounting integrity and fastening				I	←
Seat switch operating condition		I*	I		←
Seat belt integrity and operating condition			I		←
OPS					
Operating conditions		I*	I		←
Emergency stop button					
Operating conditions			I		←
Instrument panel					
Operating conditions			I		←
Horn					
Operating and mounting conditions			I		←
Lighting system (if present)					
Operating and mounting conditions			I		←
Turn signals (if present)					
Operating and mounting conditions			I		←
Reverse acoustic warning (if present)					
Operating conditions			I		←
Rear-view mirrors (if present)					
Integrity and cleaning			I		←
Rear reflection			I		←
Cabin (if present)					
Roof integrity			I		←
Doors, side window, tailgate integrity and operating condition			I		←
Heated windows integrity and operating condition			I		←
Wiper integrity and operating condition			I		←
Heater integrity and operating condition			I		←
Lubrication					
General status - see Lubrication Chart chapter					I ←



Lubrication Chart

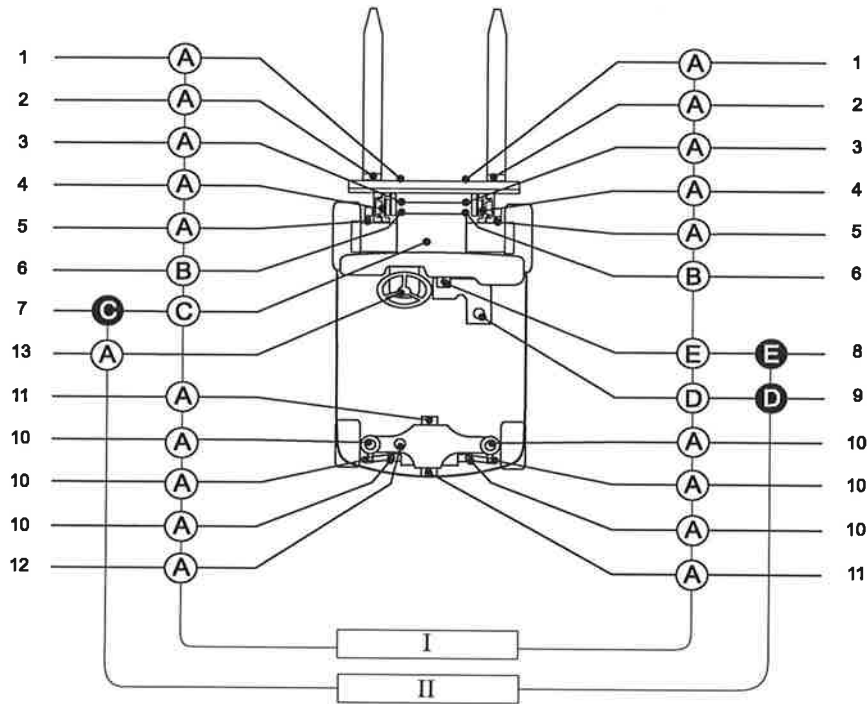

- (1) Side Shifter (*)
- (2) Fork positioning pins
- (3) Chain securing tie rods
- (4) Mast guides (*)
- (5) Mast fasteners
- (6) Lifting chains (*)
- (7) Drive units
- (8) Brake fluid reservoir
- (9) Oil tank
- (10) Rear wheels bearings (*)
- (11) Rear axle beam pins
- (12) Swing lock cylinder (*)
- (13) Horn contact ring and contact spring

- A) Molybdenum disulfide grease
- B) Chain spray
- C) Gear oil
- D) Hydraulic oil
- E) Brake fluid

- Inspection and supply
- Replacement

- I) every 1000 hours (6 months)
- II) every 2000 hours (annually)

(*) also every 40 hours as self servicing



SERVICE DATA

Value table

Item		Value
Battery electrolyte specific gravity (20°C) (Reference)	Standard	1.280
	Limit	1.150
Tightening torques	Drive units to chassis	550
	Counterweight to chassis	680
	Overhead guard (to chassis and counterweight)	83
	Wheels hub nuts	160
	Rear axle to chassis	280
	Mast to chassis	280
Sound pressure level (L _{PA}) in accordance with EN 12053 Uncertainty K=4 dB(A)	dB (A)	71.2
Whole body vibration in accordance with in EN 13059 Uncertainty K=0.3 x a m/s ² (a:listed value)	m/s ²	0.64 +/- 0.05

* use Loctite 243

Note

- The vibration values shown above are obtained from the measurements in accordance with EN 13059.
- The magnitude of hand arm vibration of lift trucks is 2.5m/s² or below as defined in EN 13059.
- The whole body vibration values shown above cannot be used for calculating 8 hour vibration exposure in 2002/44/EC (Vibration Directive).
If calculated according to the general forklift operation pattern, the result will be lower than 0.5 m/s².
- The sound pressure values shown above can be used as the sound level at operators' ears. (Values are in accordance with EN 12053 measurement methods.)

Fuses capacity table

80 V fuses - rear compartment	Amperage (A)	24 V fuses - dashboard	Amperage (A)
F1 (key)	5	F8 (position lights) (OPT)	7.5
F2 (converter input - standard devices - 80V/24V)	15	F9 (24V power supply) (OPT)	5
F3 (horn)	5	F10 (board power supply)	10
F4 (converter output - standard devices - 80V/24V)	30	F12 (12V power supply) (OPT)	5
F5 (converter input - optional devices - 80V/24V)	15	F13 (24V devices supply)	2
F6 (converter output - optional devices - 80V/24V)	30	F14 (front working lights)	7.5
F7 (converter input - optional devices - 80V/12V)	5	F15 (front wiper) (OPT)	7.5
		F16 (rear wiper) (OPT)	7.5
		F17 (heater) (OPT)	5
		F18 (rear working lights)	7.5
Drive power fuse	400	F19 (car audio, room light) (OPT)	7.5
Lift and steering power fuse	300	F20 (heated rear window) (OPT)	10



Truck weight table

Truck model	Weight (with battery) kg
2.0 tons short	4198
2.5 tons short	4553
2.5 tons	4809
3.0 tons short	5199
3.0 tons	5161
3.5 tons	5593

Data are referred to standard models

Battery requirements table

Type	Truck model	Case dimensions mm			Minimum required battery weight (with case) kg	Voltage / Nominal capacity V / Ah
		Front to rear length X	Width Y	Height Z		
Standard (High capacity)	2.0 tons short	567	1028	784	1238	80 / 420 (465)
	2.5-3.0 tons short	711	↑	↑	1558	80 / 560 (620)
	2.5-3.0-3.5 tons	855	↑	↑	1863	80 / 700 (775)
Fork pocket	2.0 tons short	564	1026	627	965	80 / 375
	2.5-3.0 tons short	708	↑	↑	1210	80 / 500
	2.5-3.0-3.5 tons	852	↑	↑	1458	80 / 625

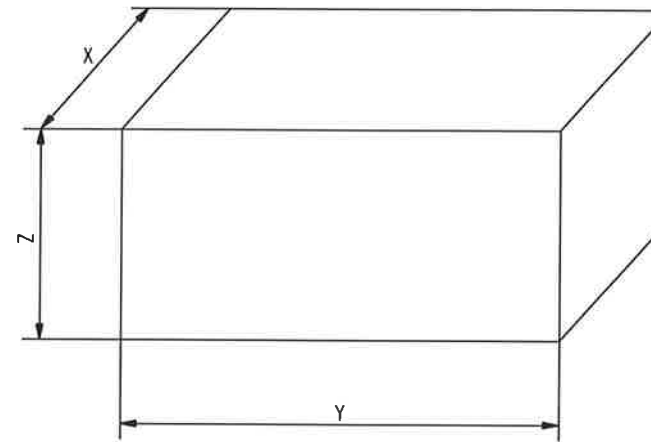

Wheels & Tyres table

Truck model	Type	Tyre size	Remarks
2.0 tons short	Front	23x9-10	Superelastic
2.5 tons short			Non Marking
2.5 tons			option
3.0 tons short	Front	23x10/12	Superelastic
3.0 tons			Non Marking
3.5 tons			option
all models	Rear	18x7-8	Superelastic
			Non-Marking
			option

Lubricants & Fluids capacity and type table

Applicable place	Capacity	Type
Drive gear units	1 L	Mobilfluid 424 or equivalent
Brake fluid	0.95 L	Mobilfluid 424 or equivalent
Hydraulic oil	25 L	Standard truck: VG 32; Wladoil HY SY HVI 32, or Agip Arnica 32, or equivalent Cold storage truck: VG 15; Wladoil HY SY HVI 15, or Agip Arnica 15, or equivalent
Chassis and mast; Grease fitting	Proper amount	Standard truck: molybdenum disulfide grease; Mobilgrease Special or equivalent Cold storage truck: molybdenum disulfide grease; Esso Beacon 32S or equivalent
Mast lifting chains	Proper amount	Interflon Fin Lube TF, or Klüberoil 4UH1-32N, or Rexnord kadespray REXOIL, or equivalent
Battery	Proper amount	Distilled water
Wiper fluid	Proper amount (max 2.1 L)	Standard truck: standard automotive windshield washer fluid Cold storage truck: low temperature automotive windshield washer fluid

Notice:

Do not mix different types of oils



TRUCK DIMENSIONS

Q	2.0 tons short	2.5 tons short	2.5 tons	3.0 tons short	3.0 tons	3.5 tons
b1	1195 mm	←	←	←	←	←
b10	986 mm	←	←	946 mm	←	←
b11	940 mm	←	←	←	←	←
α/β	5°/8°	←	←	←	←	←
h1	2235 mm	←	←	2395 mm	←	←
h2	120 mm	←	←	125 mm	←	←
h23	3340 mm	←	←	←	←	←
h4	3999 mm	←	←	4045 mm	←	←
h6	2215 mm	←	←	←	←	←
h7	1143 mm	←	←	←	←	←
h10	500 mm	←	←	←	←	←
m1	95	←	←	←	←	←
m2	127	←	←	←	←	←
l1	3140 mm	3284 mm	3429 mm	3334 mm	3449 mm	3479 mm
l2	2140 mm	2284 mm	2429 mm	2334 mm	2449 mm	2479 mm
x	420 mm	←	←	440 mm	←	←
y	1431 mm	1575 mm	1720 mm	1575 mm	1720 mm	1720 mm
c	500mm	←	←	←	←	←
s/e/l	40x100x1000 mm	←	←	45x100x1000 mm	←	45x125x1000 mm
Wa	1872 mm	2003 mm	2138 mm	2032 mm	2138 mm	2167 mm
Lat (*)	3692 mm	3823 mm	3958 mm	3872 mm	3978 mm	4007 mm

(*) with pallet 1200mm long

Data are referred to models equipped with:

- superelastic tyres
- standard V3300 mast

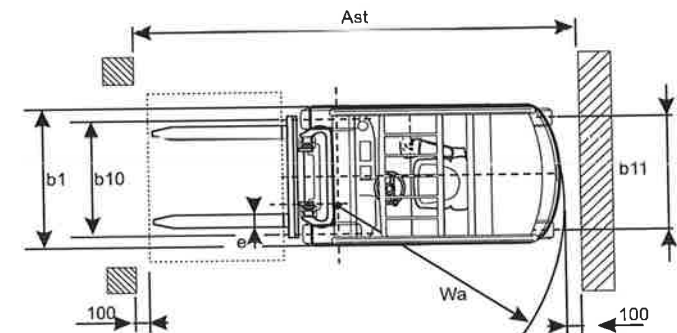
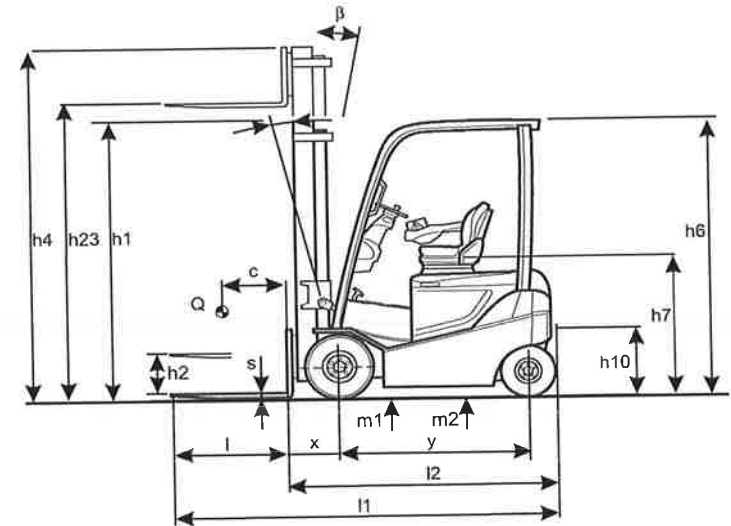



TOYOTA

TOYOTA MATERIAL HANDLING EUROPE

EC DECLARATION OF CONFORMITY

We

Toyota Material Handling Europe AB
Svarvargatan 8 SE 59581 Mjölby
Sweden

Declare that:

the counterbalanced trucks

Make: **CESSAB**

Type: **8FBMKT20**
8FBMKT25
8FBMKT30
8FBMT25
8FBMT30
8FBMT35

are in compliance with:

The Machinery Directive 2006/42/CE in its last active version:

The Electromagnetic Compatibility Directive 2004/108/CE and following amendments, as manufactured according to the Harmonised Standard EN 12895

Person entitled to constitute the technical file (for the Directive 2006/42/EC) :

First name:
Name:

Address: Toyota Material Handling Europe AB
Svarvargatan 8 SE 59581 Mjölby
Sweden

Mjölby, / /2013

Signature

Toyota Material Handling Europe AB
Svarvargatan 8 • SE-595 81 Mjölby • Sweden
Tel: +46 142 880 00 • www.toyota-forklifts.eu
Company N° 658491-8637

